

Regulation of Porphyrin Synthesis

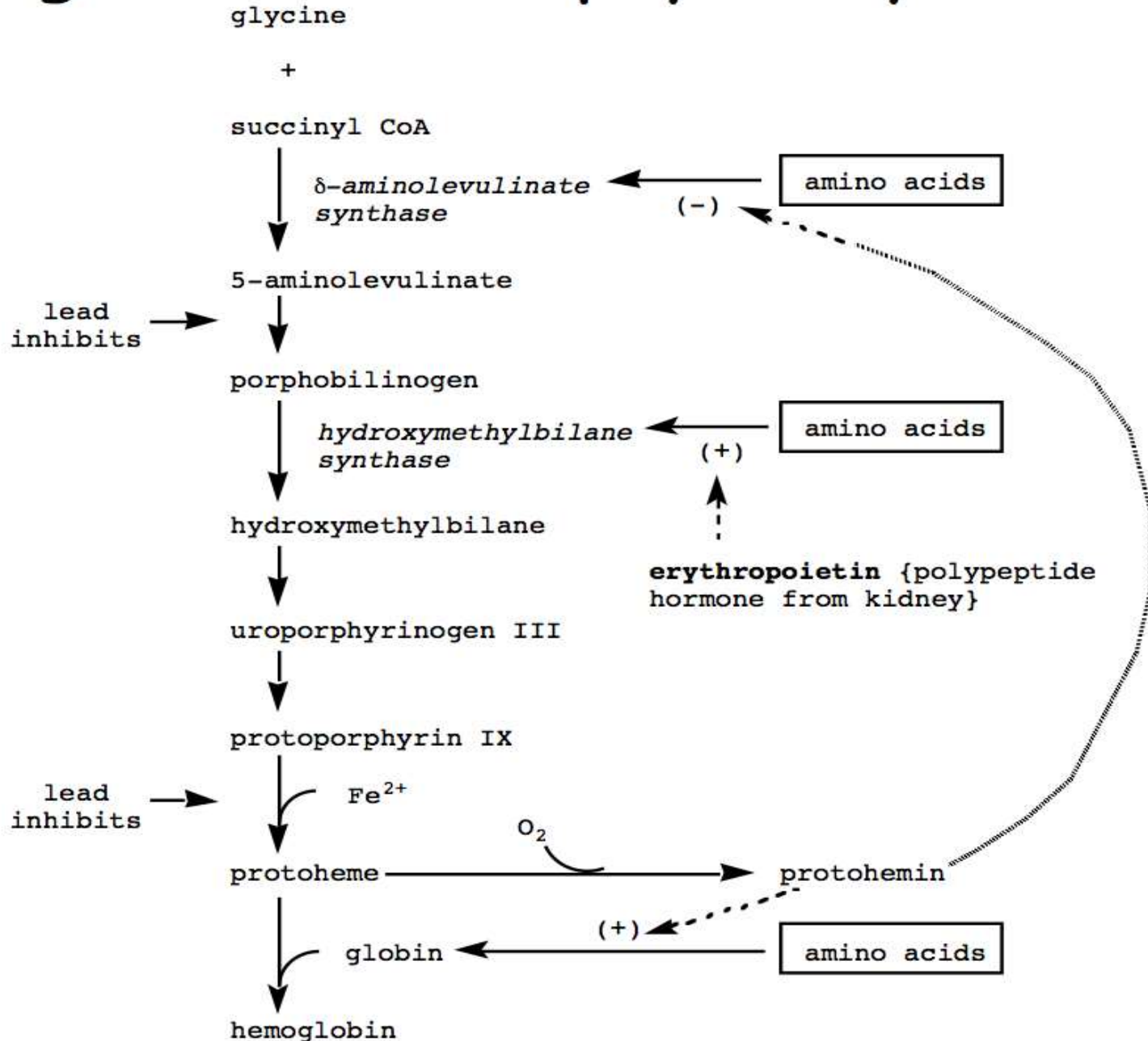

** **ALA Synthase** is controlled by the final product [**Protoheme**]
- If there is **↑ in protoheme production**, it will be **oxidized** to produce [**Protohemin**] which 3 effects: 1 (+) // 2 (-)

1) **Negative effect** on the **ALA synthase** enzyme

2) **Positive effect** to the **globin synthesis** to bind with **protohemin** + product **hemoglobin**

[globin + protohemin \longrightarrow hemoglobin]

3) Prevent the transportation of ALA synthase enzyme from the cytosol to the mitochondria

** Erythropoiten **stimulate** the synthesis of [**Hydroxymethylbilane**] enzyme which participate in heme synthesis

- **Exogenous** inhibition of heme synthesis by lead

Lead inhibits: 1) **ALA dehydrogenase** or **Porphobilinogen**

2) **Ferrocheletase**

Regulation of iron absorption and transport

- Iron for synthesis of heme, Fe-S centers and other non-heme
- Iron is obtained from:
 - 1- The diet
 - 2- Release of recycled iron from macrophages of the reticuloendothelial system that ingest old & damaged erythrocytes. (iron is re-utilized in the liver to make new erythrocytes) (iron is not lost when RBCs die).
- There is no known mechanism for iron excretion.
- Iron is significantly lost only by bleeding, including menstruation in females.
- Small losses occur from sloughing of cells of skin & other epithelia.

****الدكتور ما شرح الـ pathway**

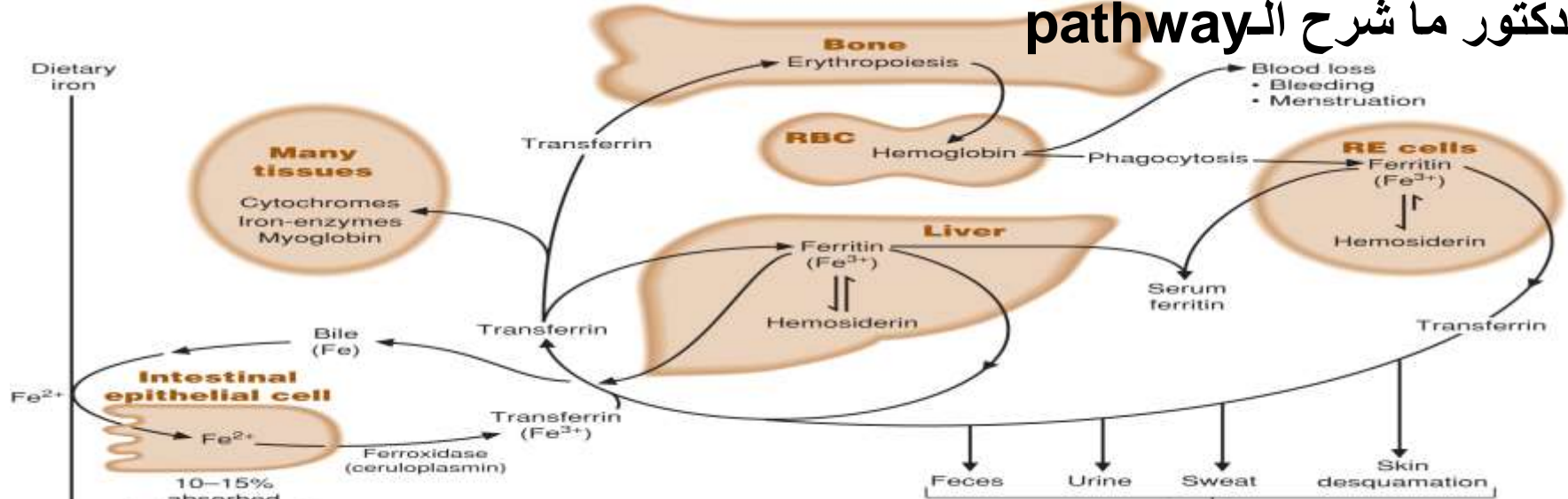

تغير في الجلد، معظم الحديد يطلع من الجسم على هاض الشكل.
 اما feces, urine, sweat مش كثير

Iron metabolism and proteins

- Many proteins have been identified playing roles in iron metabolism such as **ferritin** or **transferrin** are the main cargos of blood iron, whereas peptides such as iron regulatory proteins, hepcidin (**hormone secreted by liver to regulate iron absorption**), and matriptase2 (**play a role in storage, absorption and utilization of irons**) are [FIRST GROUP] key determinants of iron regulation at different physiological levels.

**** Deficiency of any of those 3 proteins will result in invaluable treatment.**

- A set of different proteins, notably **divalent metal transporter-1**, **ferroportin**, and transferrin receptors in association with ferroxidases such as **duodenal cytochrome B**, **ceruloplasmin** and **heme carrier protein**, are involved in **[SECOND GROUP]** the cellular membrane transportation of iron. **(carry the iron from intestine to the site of storage [reticuloendothelial system (liver, spleen, bone marrow)] then they carry it to the site of utilization)**

- Others proteins such as **myoglobin, Hb, catalase, peroxidase, cytochromes** and many different enzymes are the **[THIRD GROUP]** 'end' products of iron metabolism **(the products after storage, absorption, utilization of iron)**, because they require iron for their functions.

**** if this group was inhibited, utilization of iron will accumulate in liver so Hemosiderosis.**

Absorption of Iron

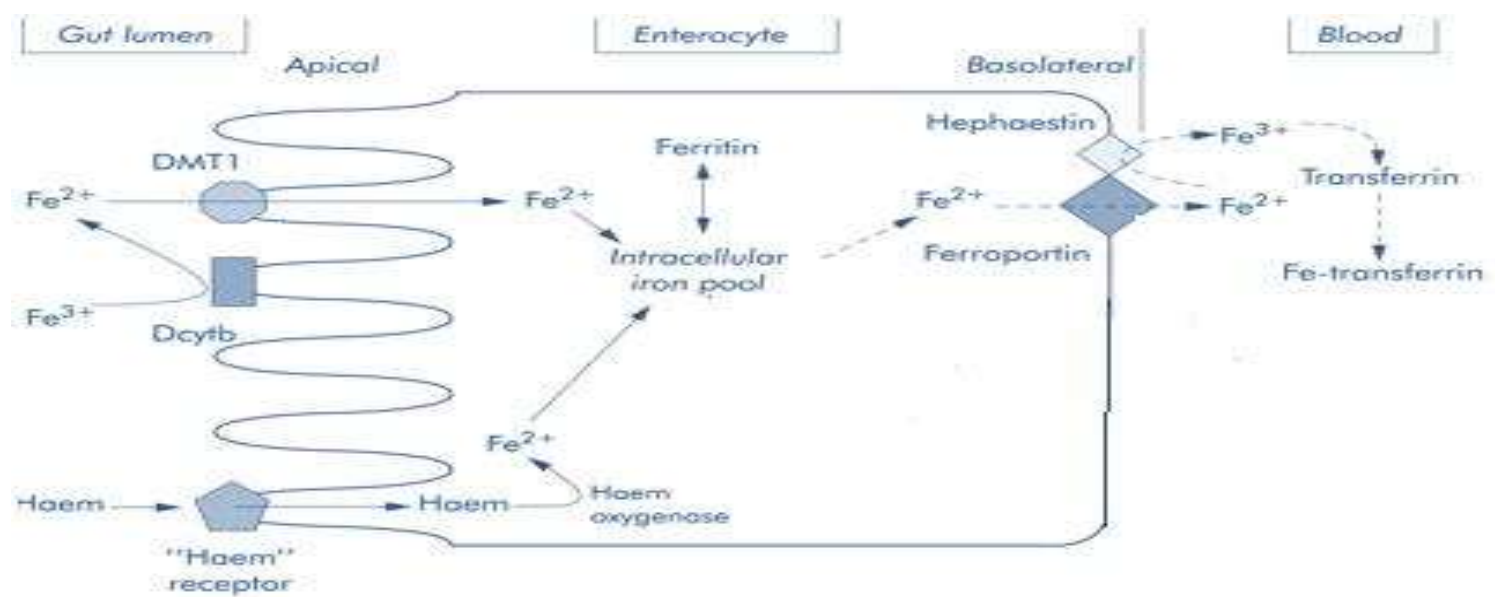

- When we take iron from diet, it's in Salt form (ferric-chloride/sulfate...) but it can't be absorbed in salt form so Ionization occurs.

** Patients with IDA they get treated by Iron + Vit. C (because vit. C facilitate ionization – يفكّ الحديد من الملح) so it will be on Ferric (Fe+3) state. (Fe+3 can't get through intestine mucosa, it should be on Fe+2 form) (if iron needs to bind to any protein, it should be on Fe+3 form)

Continue..

** Storage of iron in intestinal mucosa is temporary.

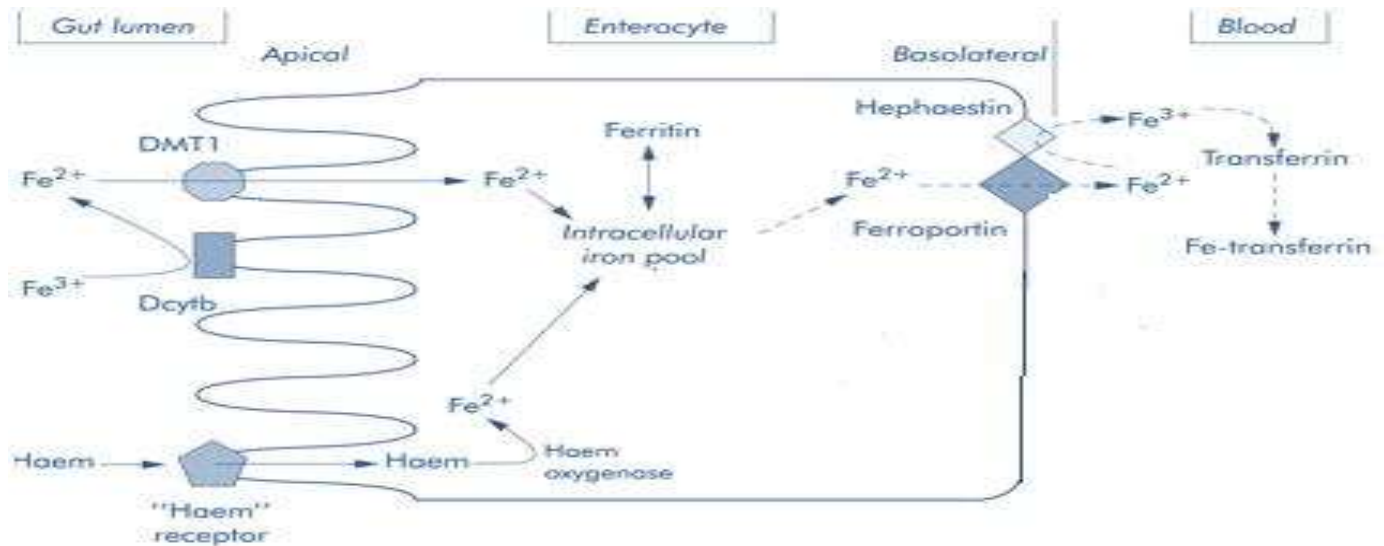

- Fe³⁺ is ionized by Vit. C or Glutathione or HCL or Cysteine... then it binds with Dcytb protein (Duedodenal cytochrome B) on apical surface which reduce Fe³⁺ to Fe²⁺. (Fe²⁺ can pass inside)

Fe²⁺ passes across DMT 1 protein (Divalent Metal Transporter 1), then passing intracellularly to bind with APO Ferritin to make Ferritin.

- IF we took iron from diet as Heam, it pass across "Haem" receptor at the apical surface then pass intracellularly to react with **Haem oxygenase enzyme system** to breakdown Haem into Fe²⁺, thus it binds with APO Ferritin to make Ferritin

Continue..

- 1- Iron stores within cells as a complex with apoferritin (ferritin), the main storage site is liver
- 2- Pass across basolateral membrane to be carried to transferrin through a protein ferroportin (under effect of Heparin) and hephaestin.
- 3- Then it passes in blood, thus Fe^{+2} is converted (oxidized) to Fe^{+3} by ferroxidase (aka ceruloplasmin) (Cu^{+2} – copper containing protein) (because Fe^{+3} form is able to bind with proteins) to bind with Transferrin protein. (APO ferritin is storage form of iron so it can carry more iron ions than Transferrin which carries only two iron ions since its transporting iron in the blood).
- 4- Heparin act as down regulator peptide secreted by liver.
** so IDA could be a cause of Copper deficiency instead of iron deficiency, there will be no ceruloplasmin and no transportation of iron from intestinal mucosal cells to blood.

Regulation of iron absorption and exportation by enterocytes

- Transcription of the gene for the iron transporter ferroportin is responsive to iron.
- When iron levels are high or in response to cytokines produced at sites of inflammation, hepcidin is secreted to induce ferroportin internalization and degradation, thus, leads to decreased absorption of dietary iron and decreased serum iron.
- Inversely, in the absence of hepcidin, ferroportin is maintained on the cell membrane, and iron transportation is facilitated.

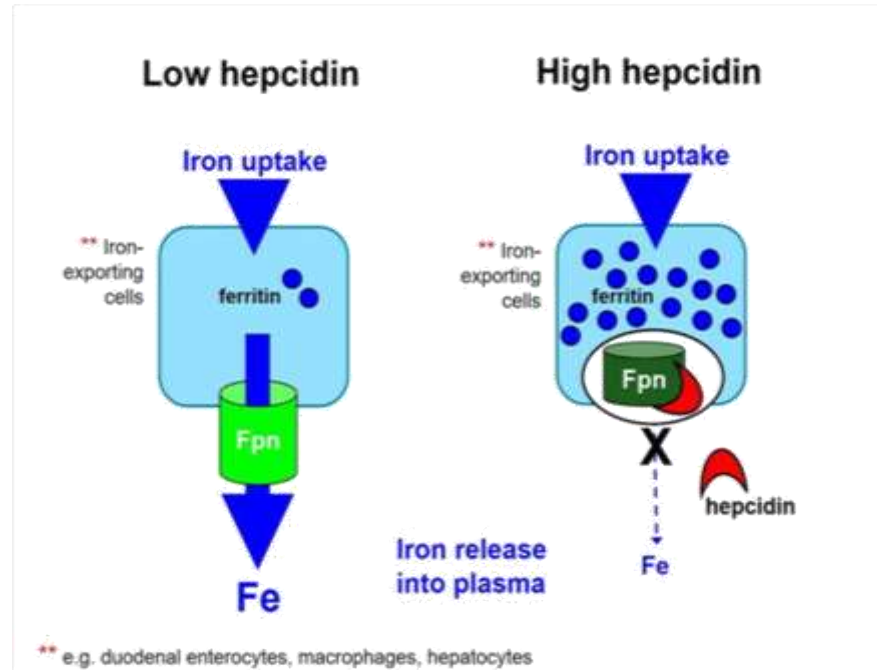

- The plasma membrane protein ferroportin mediates:
 - 1- Release of absorbed iron from intestinal cells to blood.
 - 2- Release of iron from hepatocytes (liver cells) and macrophages.
- Control of dietary iron absorption and serum iron levels involves regulation of ferroportin expression.

Transferrin-Fe complex will bind to the Transferrin receptor, then the receptor will be internalized as endosome (the complex still bounded to it) so Proton pump allow transportation of H^+ . Those H^+ will dissociate iron from transferrin to allow passage through DMT1 outside to the liver to be stored/utilized. The endosome will be externalized with Transferrin receptor, Transferrin will dissociate to go and carry another iron...

- So that's why Heparin is considered an antimicrobial peptide because by lowering serum iron it would limit bacterial growth.

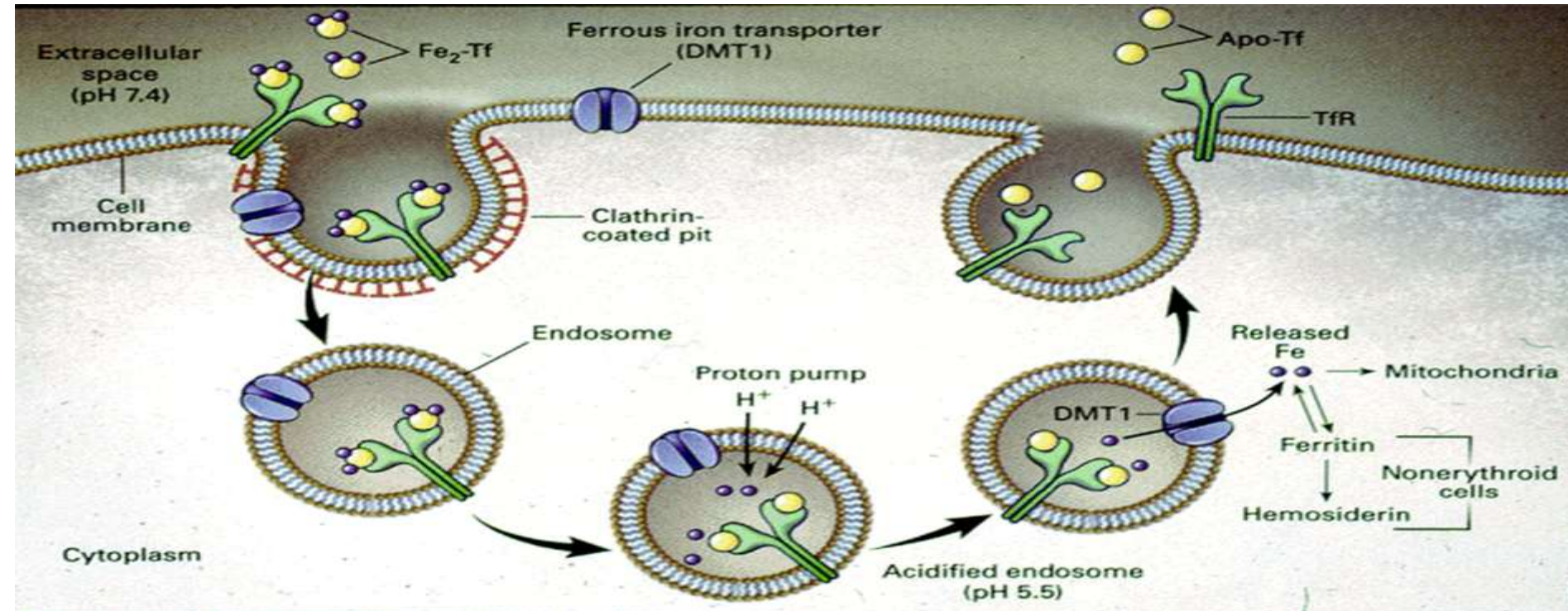

- The plasma membrane transferrin receptor mediates uptake of the complex of iron with transferrin by cells via receptor mediated endocytosis.

- Hereditary hemochromatosis is a family of genetic diseases characterized by excessive iron absorption, transport & storage.

- Genes mutated in these disorders include those:
 - 1- Transferrin receptor
 - 2- A protein HFE (Human hemochromatosis protein) that interacts with transferrin receptor to regulate iron absorption by inhibiting transferrin-receptor interaction
 - 3- Hemojuvelin, an iron-sensing protein required for transcription of the gene for hepcidin. (Hemojuvelin is iron sensing protein, so if iron is high in blood it will sense it and send a message for transcription of Hepcidin by liver cells then Hepcidin will cause internalization of ferroportin).
 - 4- Impaired synthesis or activity of hepcidin leads to unrestrained ferroportin activity, with high dietary intake and high % saturation of serum transferrin with iron.

- Organs particularly affected by accumulation of excess iron include liver and heart.

Genetic polymorphism of proteins involved in iron metabolism

- In humans, genome-wide association studies found linkage of various gene polymorphism (single nucleotide polymorphism; SNP) and iron status, notably polymorphism of the gene coding for matriptase2.
- There is an evidence that genetic polymorphism of the matriptase2 gene is associated with the risk to develop iron deficiency anemia.
- Also, the investigators found a significant association of SNPs at the transferrin gene as well as at the HFE gene with iron deficiency.

Globin synthesis

- Humans normally carry 8 functional globin genes, arranged in two duplicate gene clusters:

A- The **β -like cluster** on the **short arm of chromosome 11**.

B- The **α -like cluster** on the **short arm of chromosome 16**.

- These genes encode for 6 different globin chains: $\alpha, \beta, \gamma, \delta, \epsilon$ and ζ .

Type of Hb	Type of Globin Gene	Region	Time
Hb Gawer1 ($\zeta \epsilon$) ₂	ζ & ϵ	Yolk Sac	3 weeks of Gestation
Hb Portland($\zeta \gamma$) ₂	ζ & γ	Yolk Sac	5 weeks of Gestation
Hb Gawer II ($\alpha \epsilon$) ₂	α & ϵ		
Hb F ($\alpha \gamma$) ₂	α & γ	Liver & spleen	6-30 weeks of Gestation
Hb A ₂ ($\alpha \delta$) ₂	α & δ	Liver	30 weeks of Gestation
HbA($\alpha \beta$) ₂	α & β	Bone marrow	At Birth

Hemoglobin in adults

	Hb A	Hb A ₂	Hb F
Structure	$a_2\beta_2$	$a_2\delta_2$	$a_2\gamma_2$
Normal %	96-98 %	1.5-3.2 %	0.5-0.8 %

ζ = Zeta
 ε = Epsilon

شرح الجدول..

** At first $\zeta \varepsilon$ are ON $\alpha \beta \delta \gamma$ are OFF

- At first 3 weeks of gestation, HbGawer1 it has 2 polypeptides which are $\zeta_2 \varepsilon_2$ then after 2 weeks it will be replaced with HbPortland which has $\zeta_2 \gamma_2$ and HbGawer2 $\alpha_2 \varepsilon_2$ (so in 5th week, there are 4 active proteins)
- Afterwards, at 6th week - 30th HbF appears and $\zeta \varepsilon$ are switched OFF and $\alpha \gamma$ are switched ON.
- At 30th week HbA₂ appears with $\alpha\delta$ then at birth HbA appears with $\alpha\beta$ (eventhough it says at birth but the time of synthesis was before of birth time)

Beta Globin Gene Cluster Chromosome 11

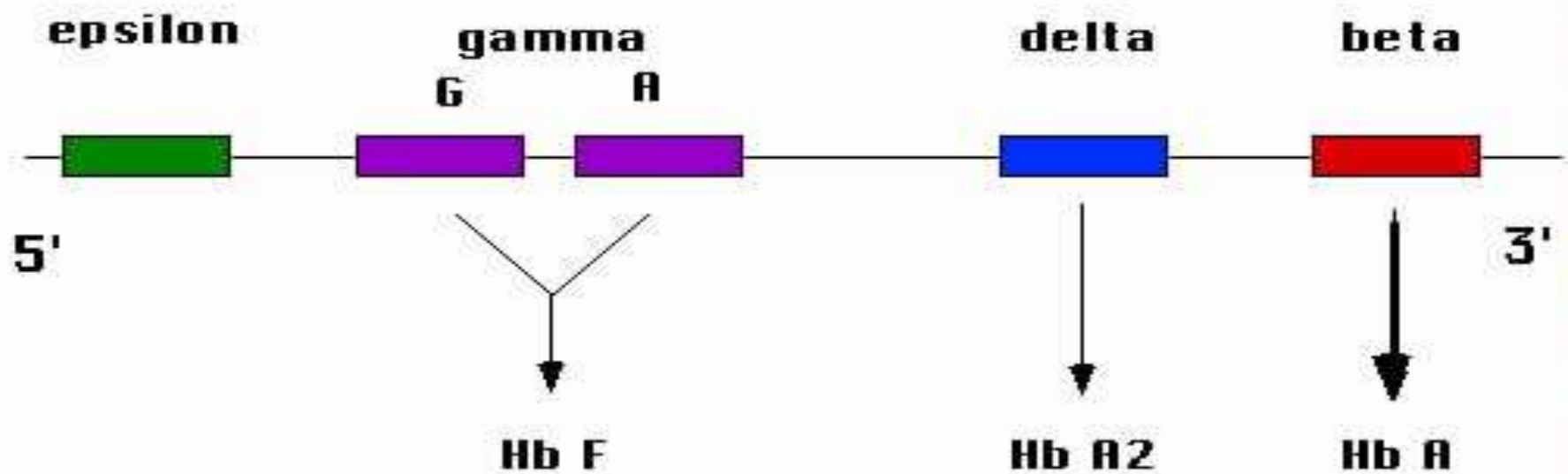

Alpha Globin Gene Cluster Chromosome 16



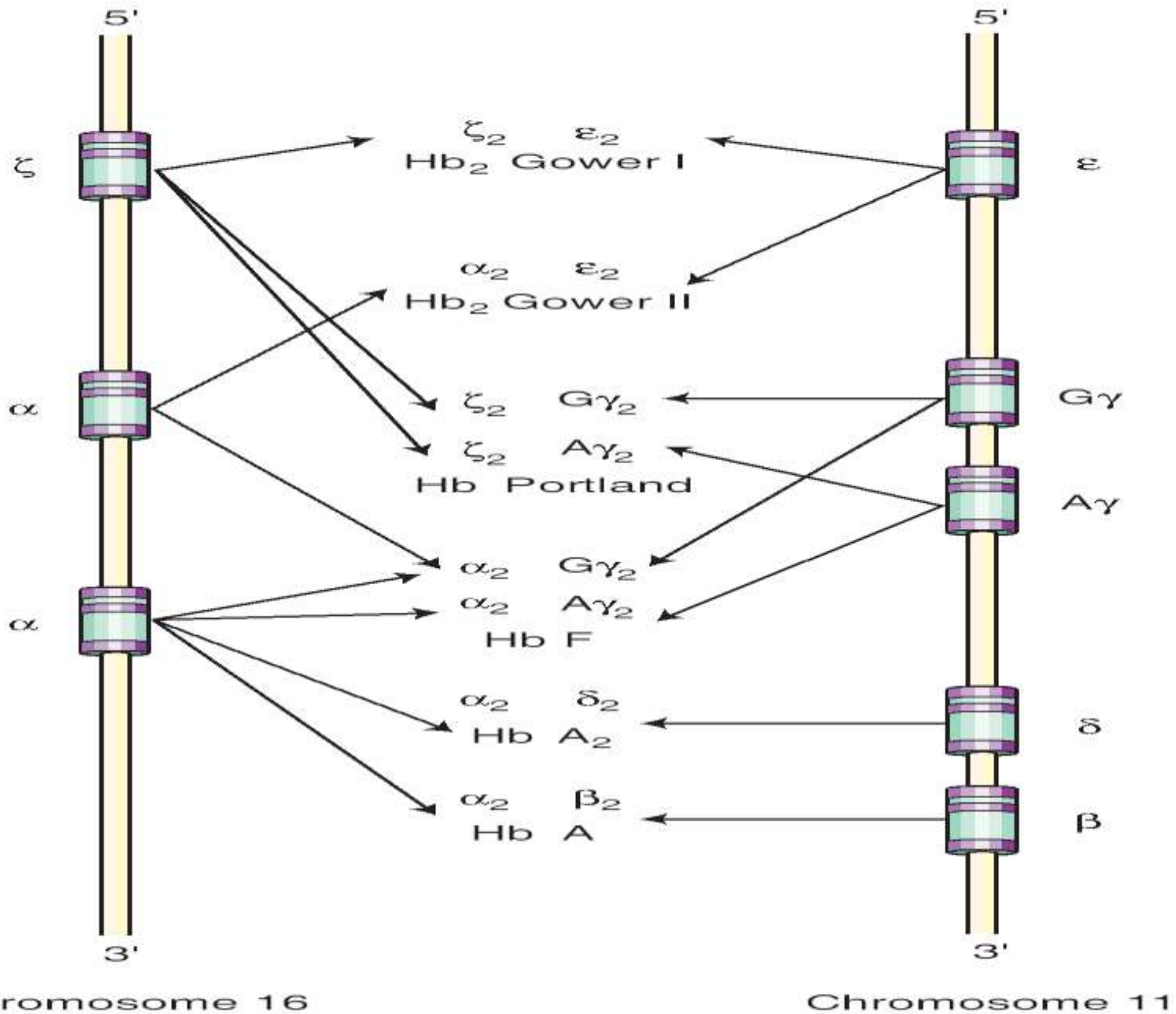

Figure 4.2 Specific chromosomes relative to human hemoglobin formation.