



WELCOME NEW CLASS

Think positive

1. **Success doesn't just find you. You have to go out and get it.**

Best
wishes

It's going to be hard, but hard does not mean impossible.

3. **Don't stop when you're tired. Stop when you're done.**

4. **Sometimes we're tested not to show our weaknesses, but to discover our strengths.**

5. **The key to success is to focus on goals, not obstacles.**

Best
wishes

PROF DR. HALA ELMAZAR

2

Introduction to cell biology



Cell biology:

- The study of normal cells structures & functions
(Cellular & Molecular levels)
- The cell is the smallest & the basic unit of a living body
- Every living body is made of different cells
- Cells varies in size from 4 to 200 microns.
- The living organisms are either unicellular or multicellular
- The cell can't be seen by naked eye but by microscope

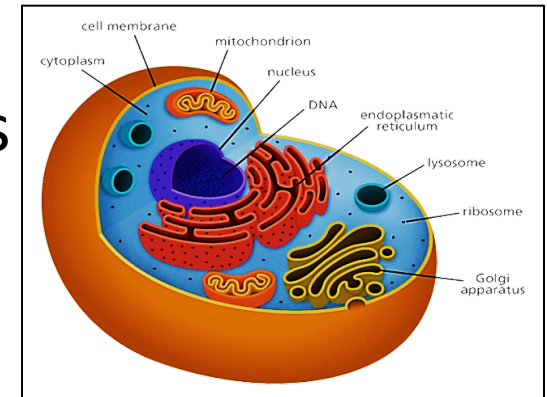

Histology (histo: tissue, ology : science):

Microscopic study of tissues of the body and how these tissues form the organs



cells

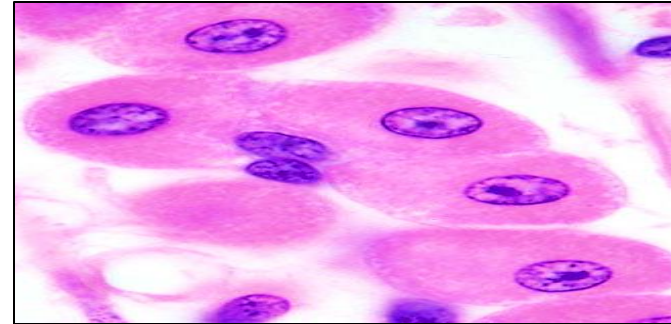

tissue

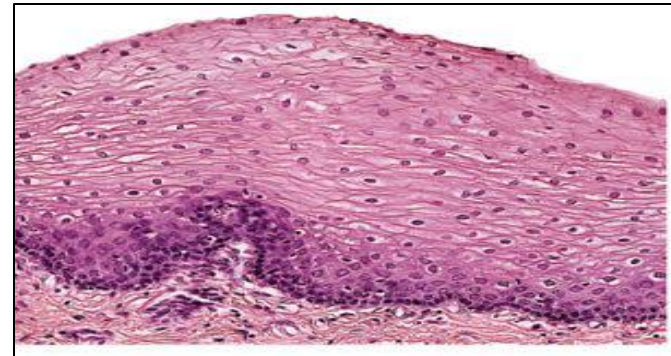

organ

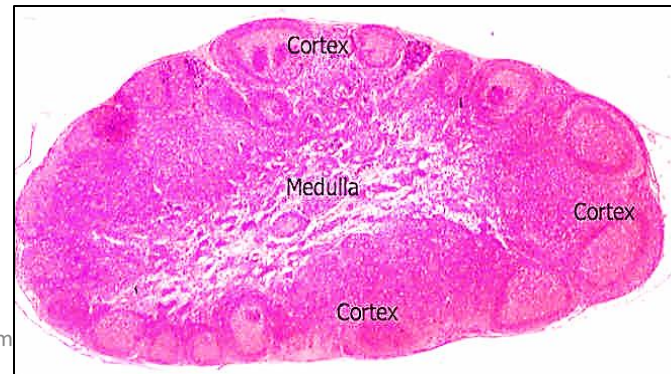

Methods of studying cell biology

- **Cell culture:** isolating the cells to study under controlled conditions (i.e. preserved homeostatic conditions)
- **Cell fractionation:** breaking the cells subsequently to their components by centrifugation
- **Chromatography:** separating the molecules in a mixture based on their physical & chemical properties (in case of proteins we uses gel instead of paper)

Chromatography

- Usually the mobile phase is a gas or a liquid, and the stationary phase is a solid, such as chromatography paper.
- The separation occurs because the various components of the mixture spread through the paper at different rates.

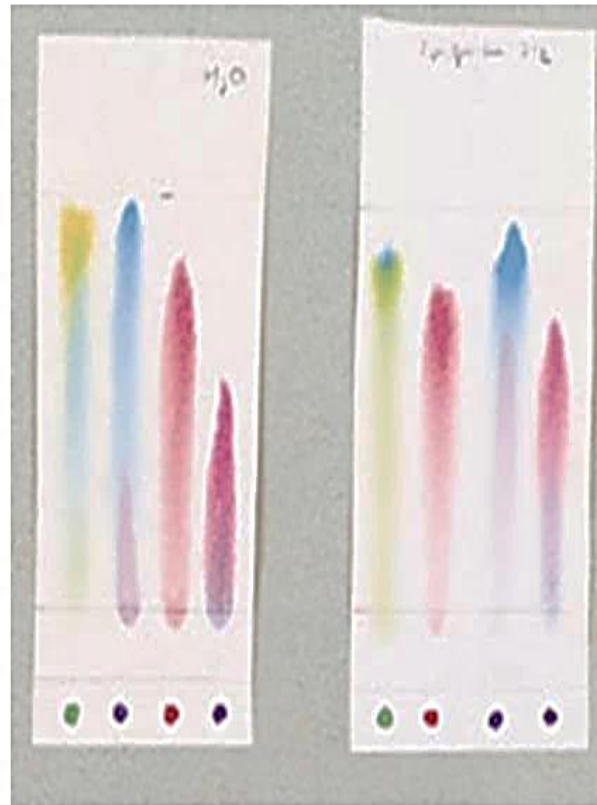

- **Electrophoresis:** separating charging molecules using an electrical field (size & charge)
- **Genetic technology:** study the gene structure and function (Isolating gene, determine unknown DNA sequence, copy genes & DNA sequence = cloning)
- **Small animal imaging (SAI):** examine the biological processes from the molecular to the organ system level in living animals. Is important for preclinical studies e.g. Positron emission tomography (PET /scan), MRI, CT

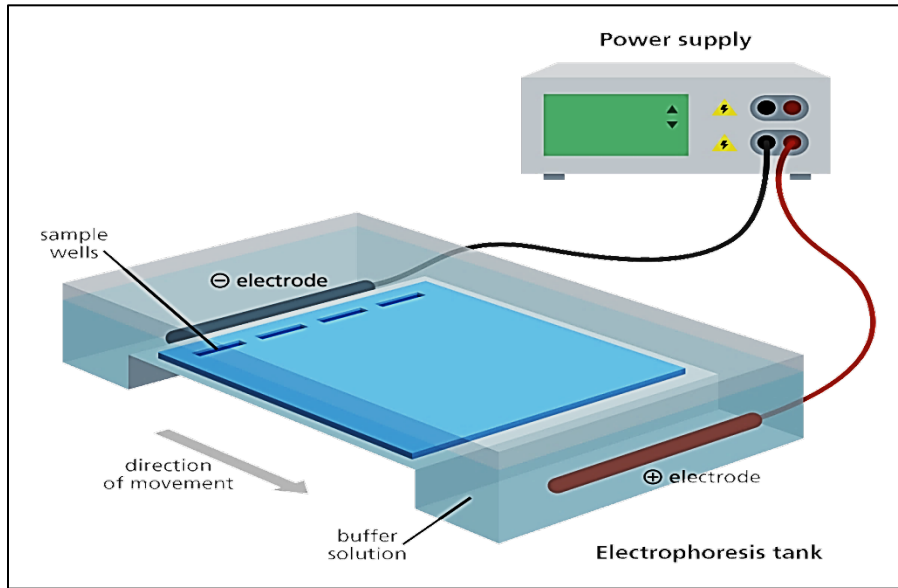

Gel electrophoresis

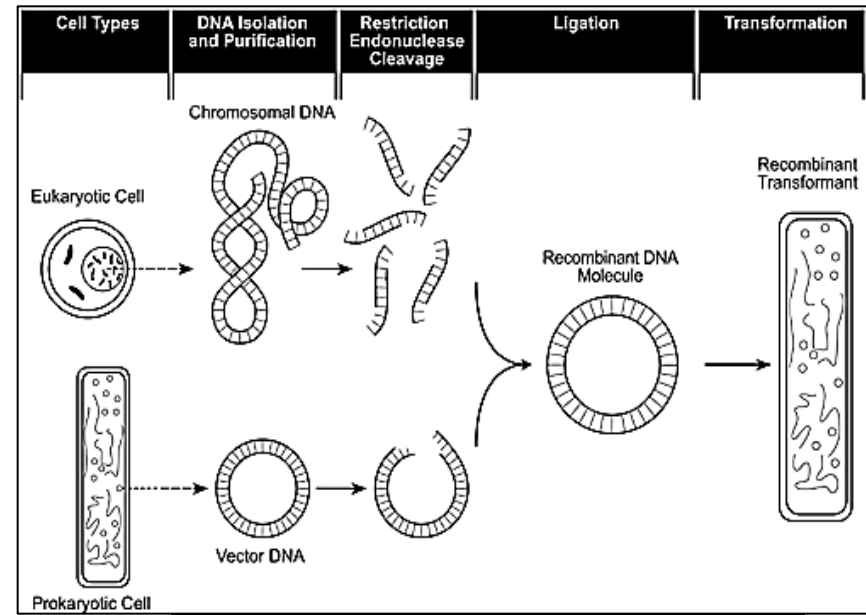

recombinant DNA technology

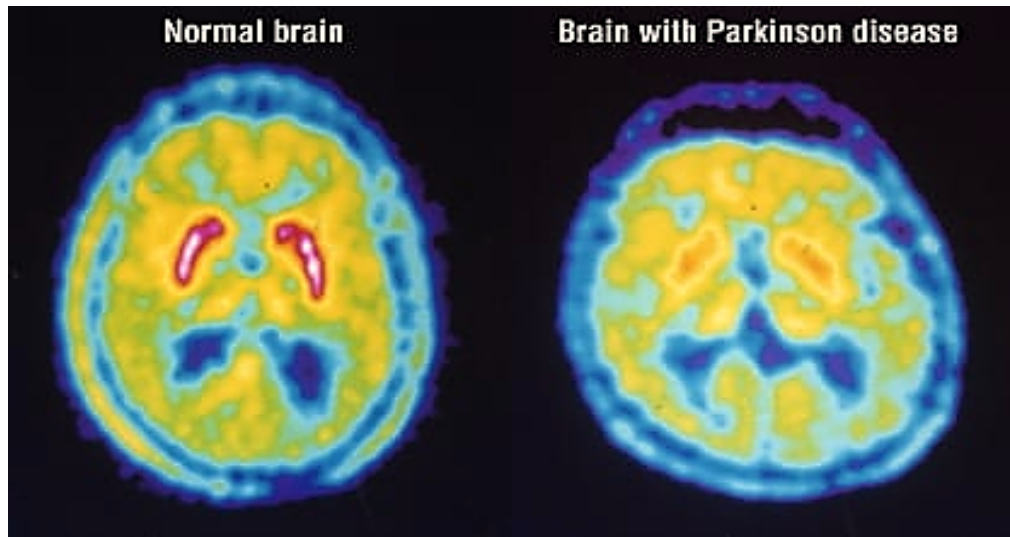

Positron emission tomography (PET/Scan)

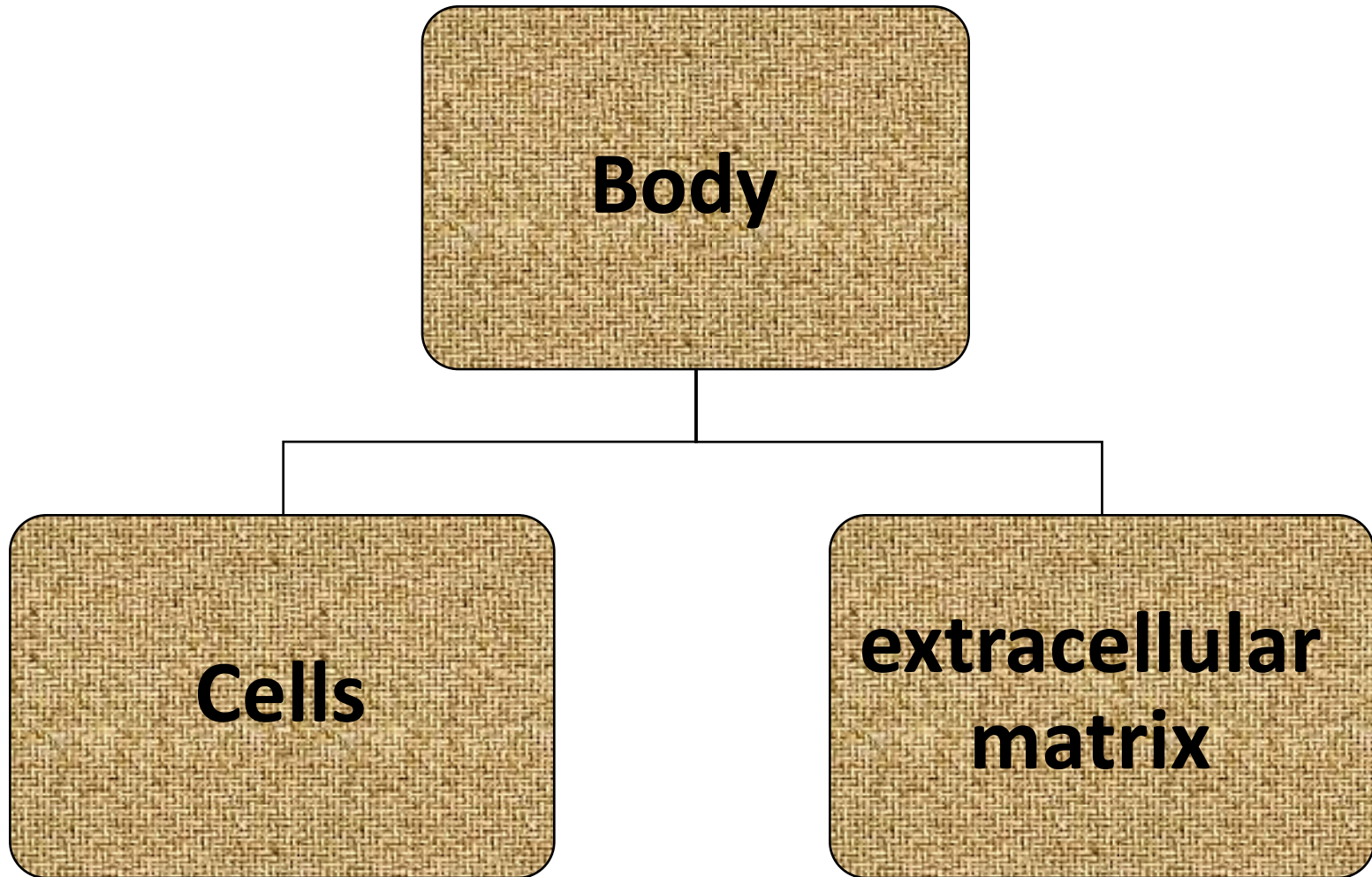

1- The cell

The cells in general are classified into :

1. Prokaryote

2. Eukaryote

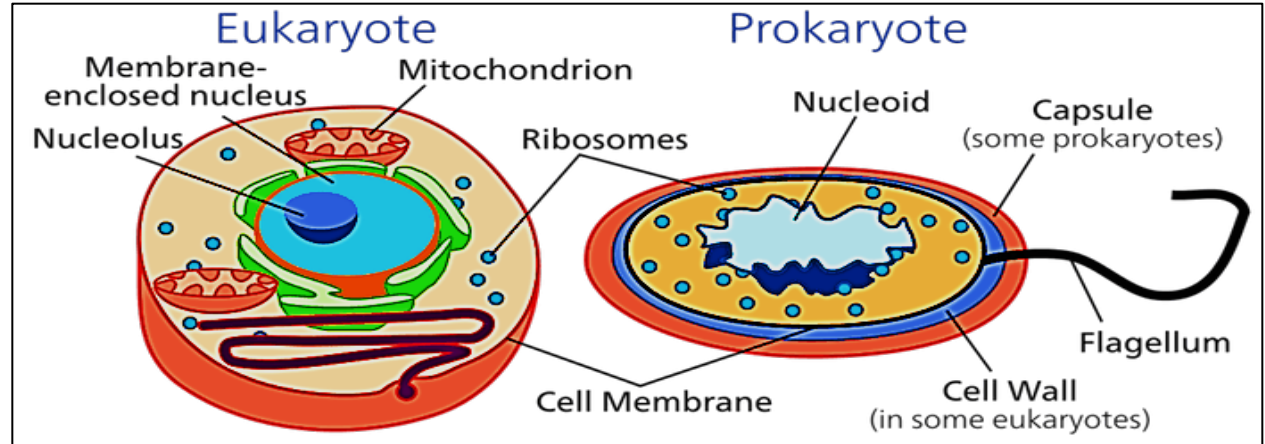

Prokaryotic cell:

lacks the nucleus, the genetic materials are scattered in the cytoplasm (nucleoid) & has No membrane bounded organelles

Eukaryotic cell

contains nucleus & membrane bounded organelles.

Both (Pro & Eu) share 4 key elements (cell membrane, cytoplasm, genetic material, ribosomes)

Prokaryote cell

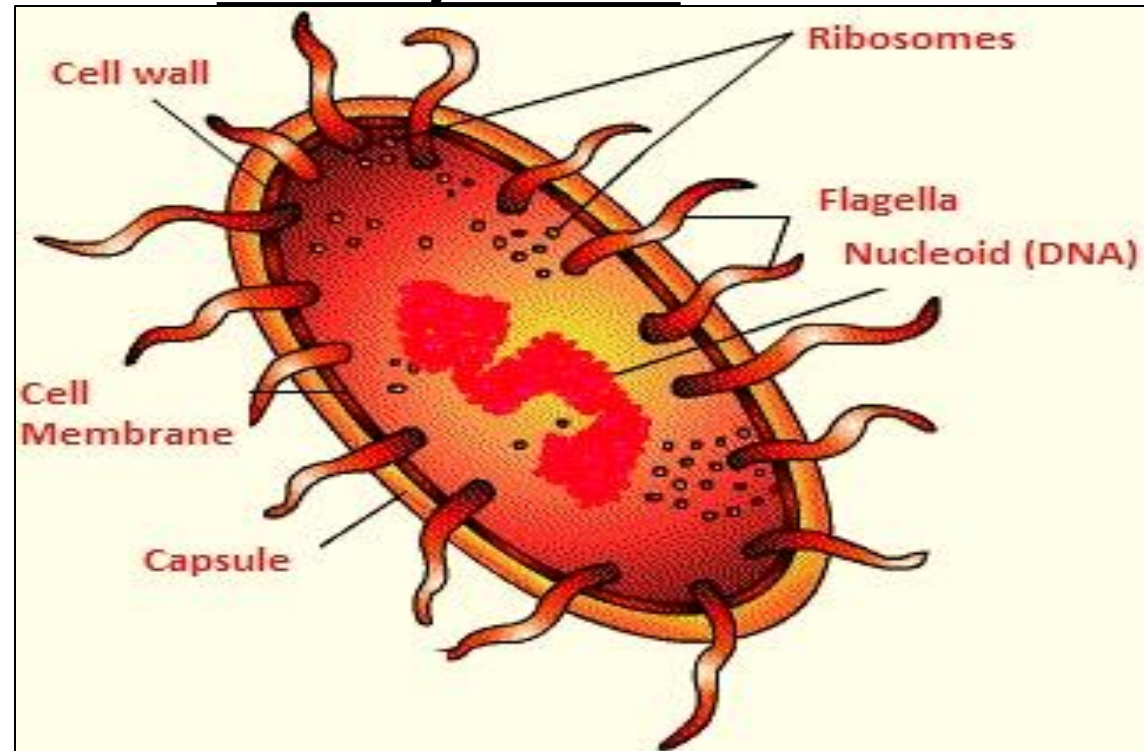

The DNA strand is circular and is called **genophore** and found in area called nucleoid

Binary fission

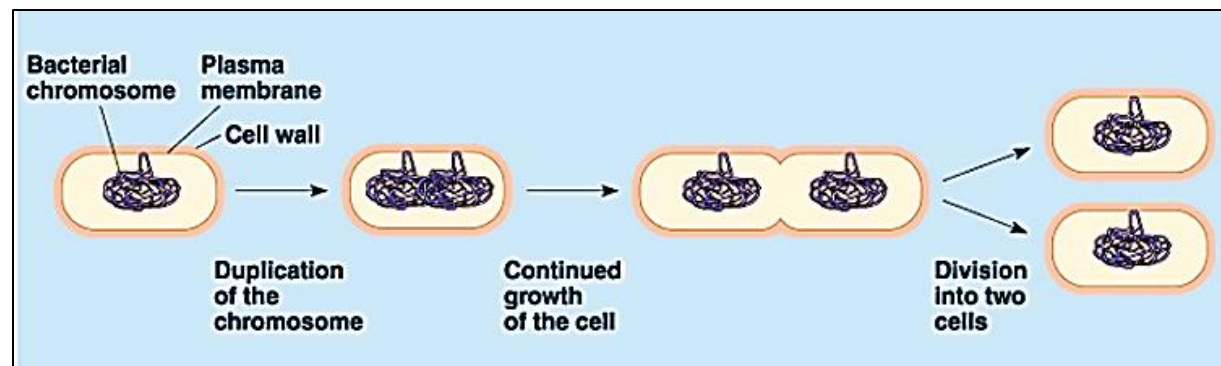

Eukaryote cell

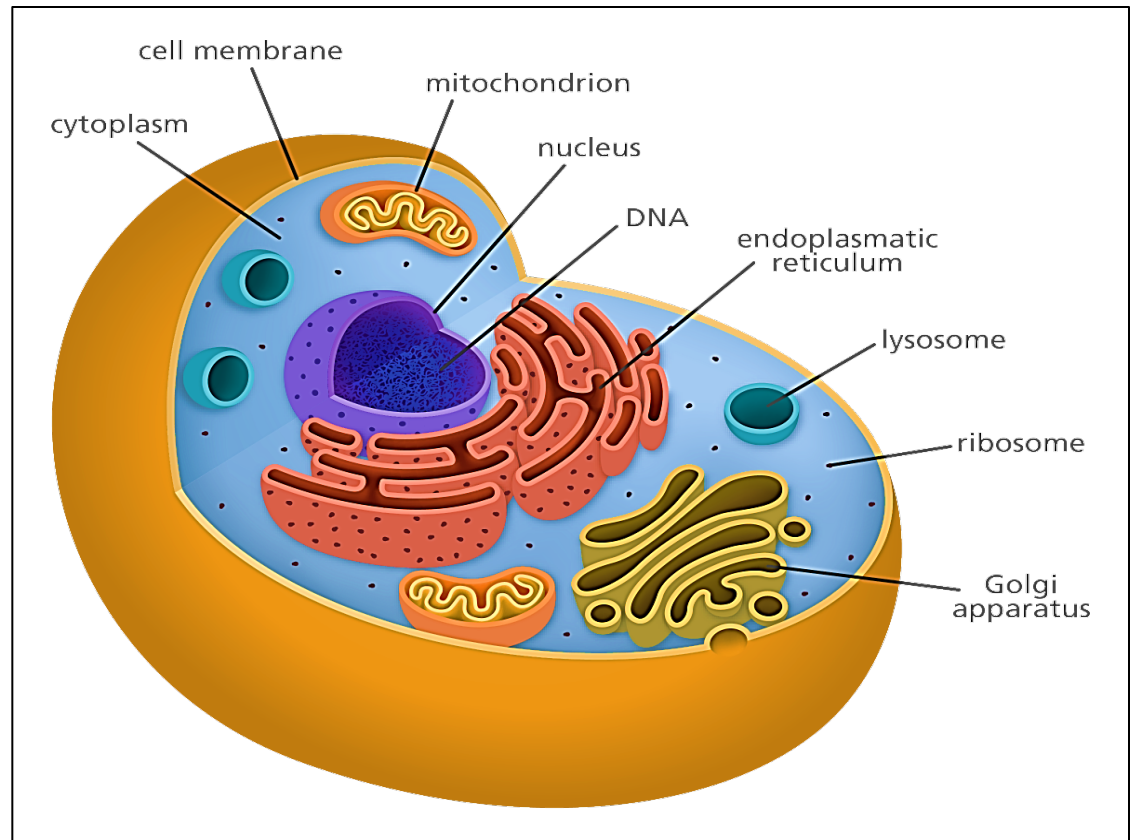

Equivalent lengths:

1 millimeter (mm) = 1000 micrometer (micron)

1 micrometer (um)= 1000 nanometer

1 nanometer(nm)= 10 angstrom

Prokaryote vs. eukaryote

	PROKARYOTE	EUKARYOTE
Meaning of name	Pro means before Karyon means nucleus	Eu means after Karyon means nucleus
Evolution of first cells	3.5 billion years ago (older type of cell)	1.5 billion years ago
Size of cells	Smaller (1-10 μm)	Larger (100-1000 μm)
Uni-/multicellular	Unicellular (less complex)	Multicellular (more complex)
Organelles	Absent	Present
Location of genetic information	Nucleoid region	Nucleus
DNA structure	Circular (usually one chromosome)	Not circular (more than one chromosome)
Reproductive strategy	Asexual	Sexual
Oxygen requirement	Anaerobic (doesn't require oxygen)	aerobic

Different cells of the body



Blood cells

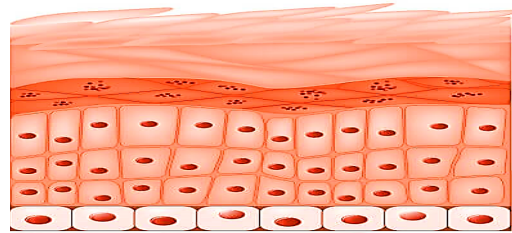

Surface skin cells



Bone cell

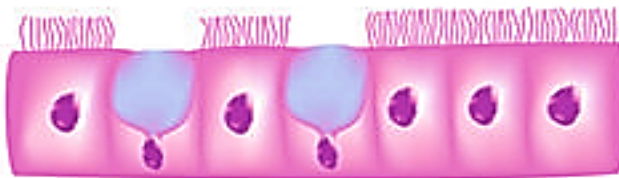

Columnar epithelial and Goblet cells



Cardiac muscle cell



Skeletal muscle cells

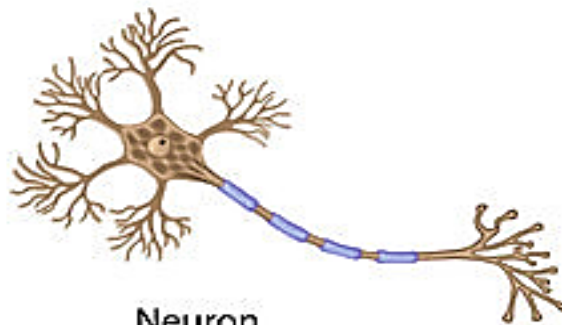

Neuron



Smooth muscle cells

Four types of tissue

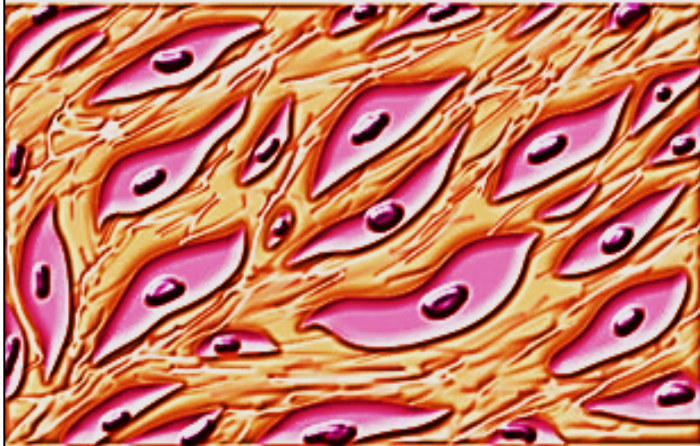

2- Connective tissue

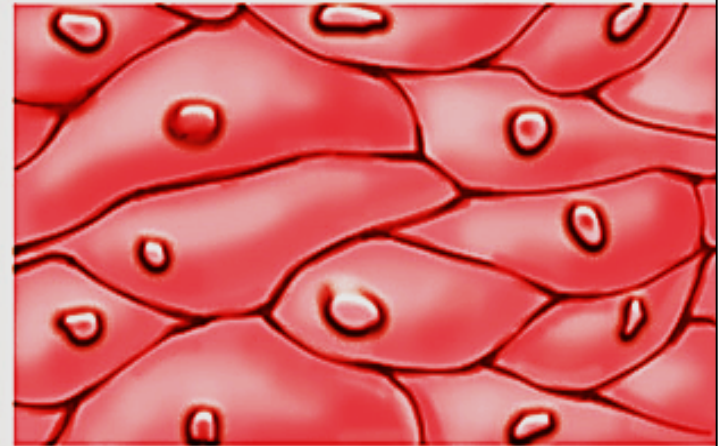

1- Epithelial tissue

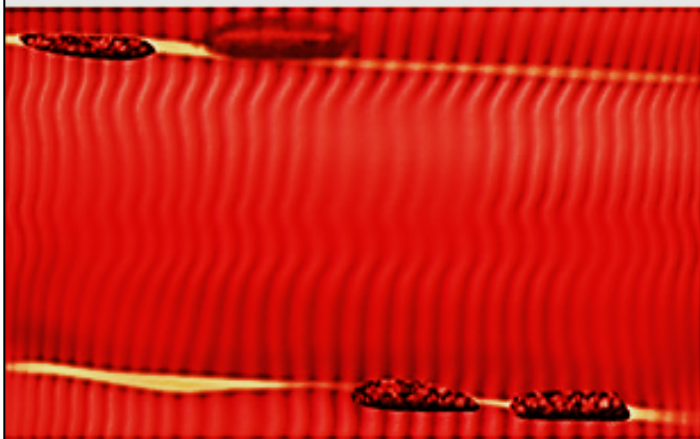

3- Muscle tissue

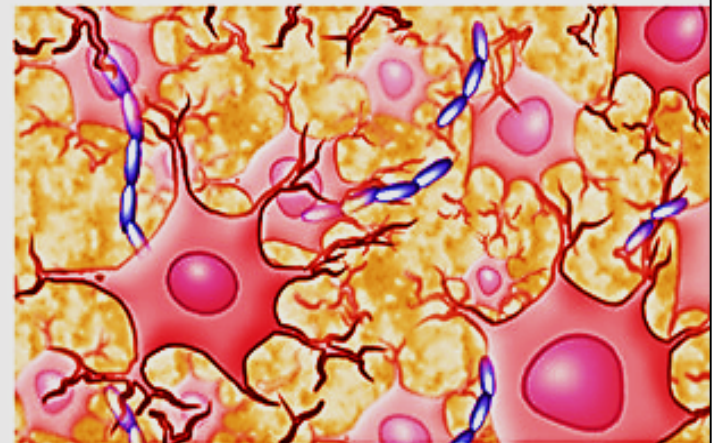

4 - Nervous tissue

2- Extracellular matrix (ECM)

- is the non-cellular component that fills spaces between cells & is secreted by the cells of the tissue
- beside its supportive role it is required for tissue morphogenesis, communication differentiation & homeostasis
- Extracellular matrix is either:

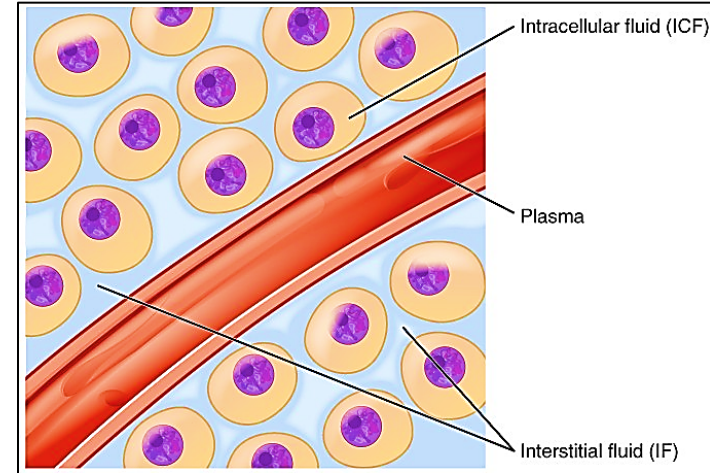

1- Interstitial fluid: thin layer of fluid surrounds the body cells : H₂O, proteins, electrolytes, acids, hormones , waste materials

2- basement membrane: is sheet-like depositions of ECM at the base of cells ... only found under epithelial cells

(plasma membrane VS. basal lamina Vs. basement membrane)

Interstitial matrix & basement membrane

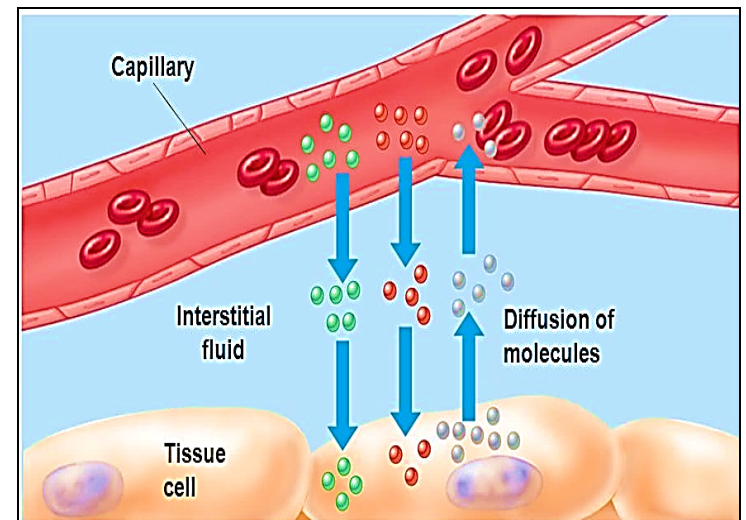
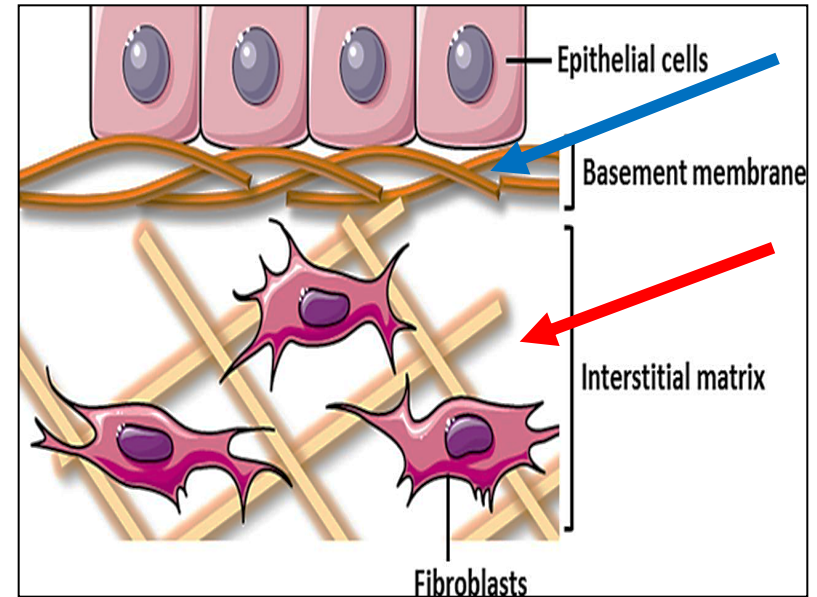
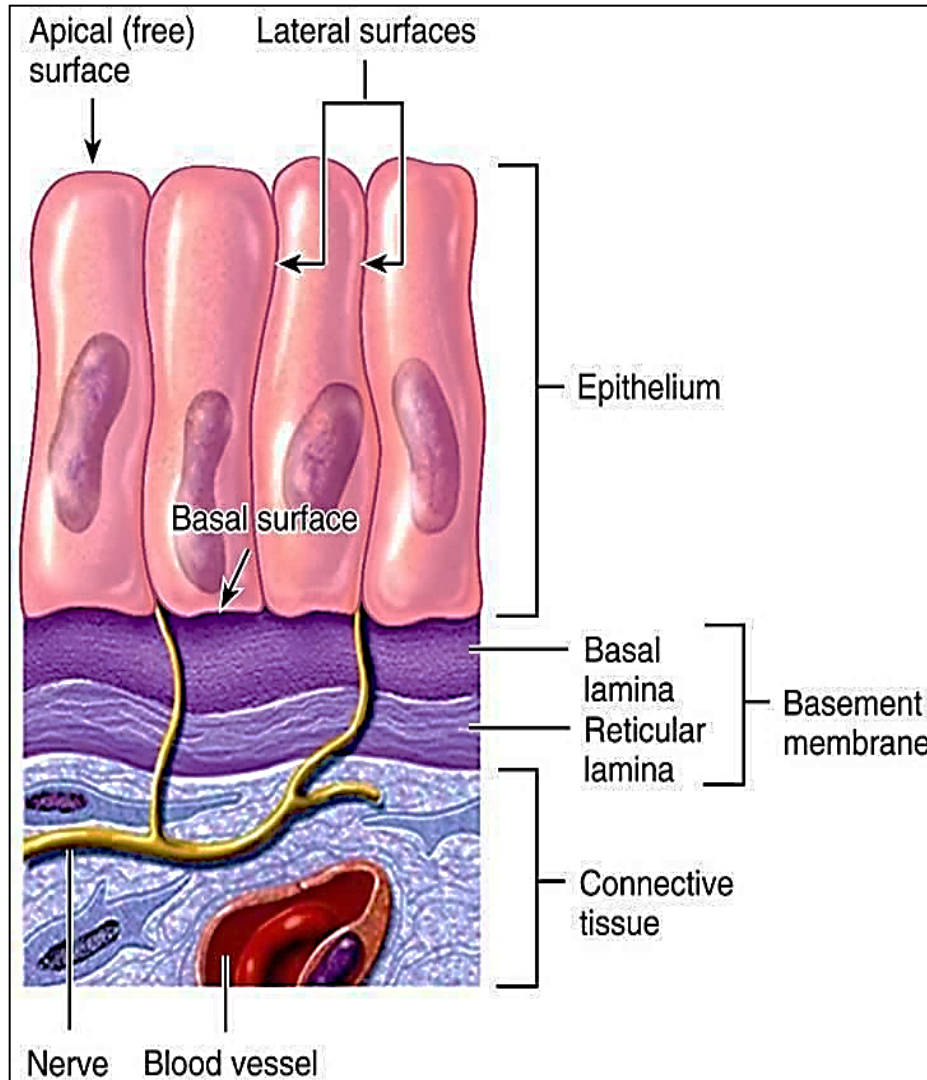

- Most epithelial cells are separated from the connective tissue beneath it by a sheet of extracellular material called basement membrane
- The basement membrane is usually visible with light microscope
- Is formed by 2 layers basal lamina & reticular lamina

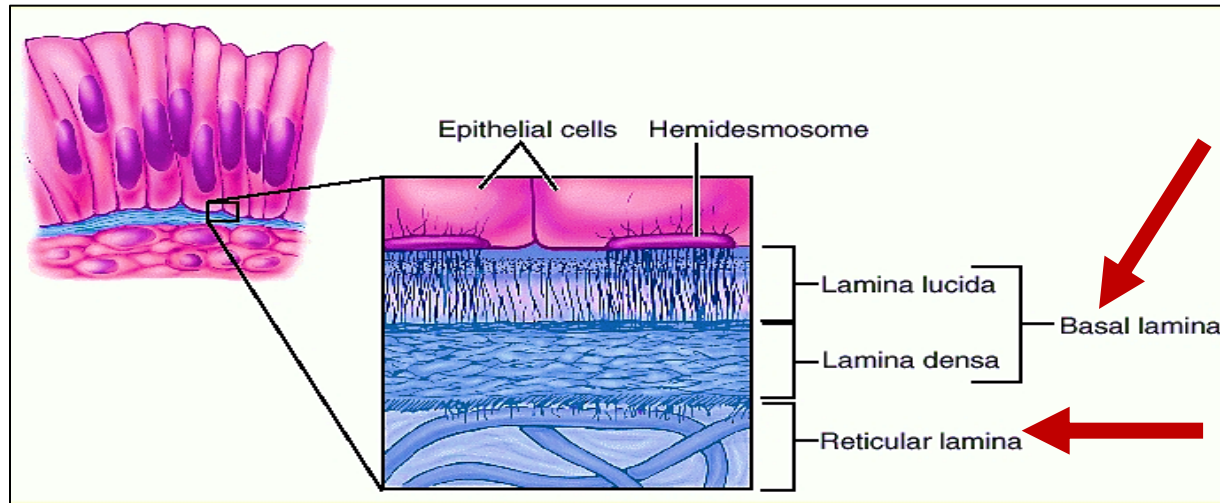

- Function of basement membrane :1- **Anchoring epithelial cells to underlying tissue**, 2- **pathway for cell migration**, 3- **wound healing**, 4- **barrier between epithelial cells & CT**, 5- **participate in filtration of blood in kidney**, 6- **early stages in cancer called carcinoma in situ (limited to epithelial layer)**

- The basal lamina itself is visible with EM about 20 -100 nm in thickness. secreted by epithelial cells
- Basal lamina consists of delicate network of fine filaments lamina densa & an electro lucent layer on one or both sides called lamina lucida

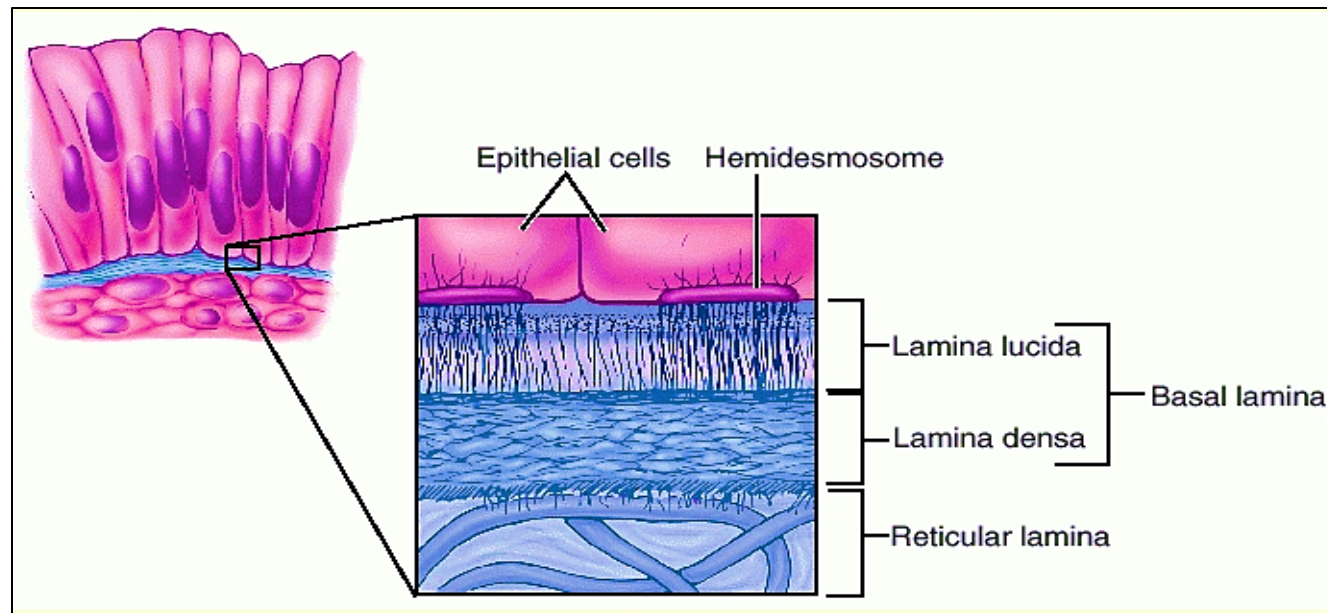

- **NB: in diabetes mellitus , the basement membrane of small blood vessels especially in retina & kidney became thick**

- The main components of basal lamina are: **type IV (4) collagen**, **laminin** (glycoprotein), **entactin**, and **proteoglycan**

- **The reticular lamina** is formed by reticular fibers, usually thicker than basal lamina, secreted by connective tissue cells (fibroblasts)

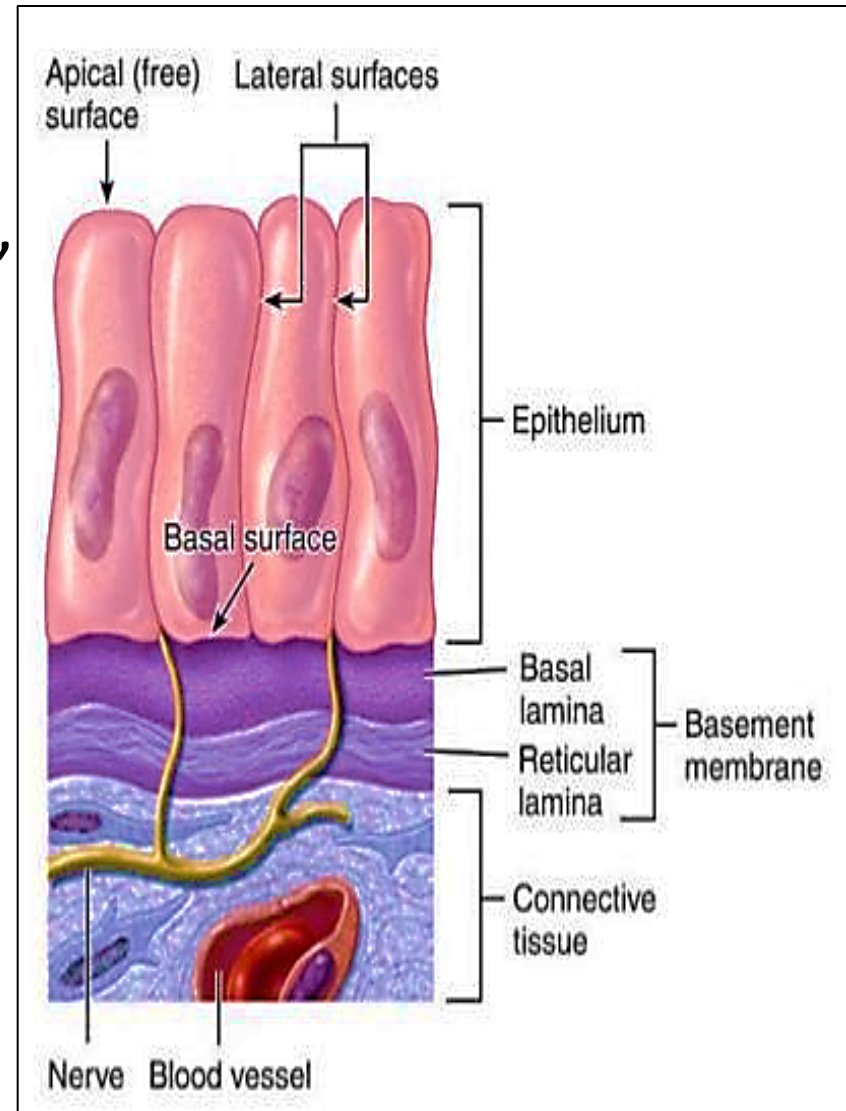

- The muscle fibers are coated by an extracellular matrix material called the basement membrane, which composed of 2 layers: an internal basal lamina directly attached to plasma membrane of myofibrils (Sarcolemma), and an external reticular lamina.
- Extracellular matrix surrounding muscle fibers is composed of: type 4 collagen, laminins, fibronectin, & proteoglycans. ECM gives mechanical support to myofibers during contraction, gives support to nerves & vessels present in skeletal muscle tissue, & act as a barrier between endothelium and muscle cell surface and in signaling
- Epithelial cells are tightly bound together, the ECM is scanty consisting mainly of basal lamina

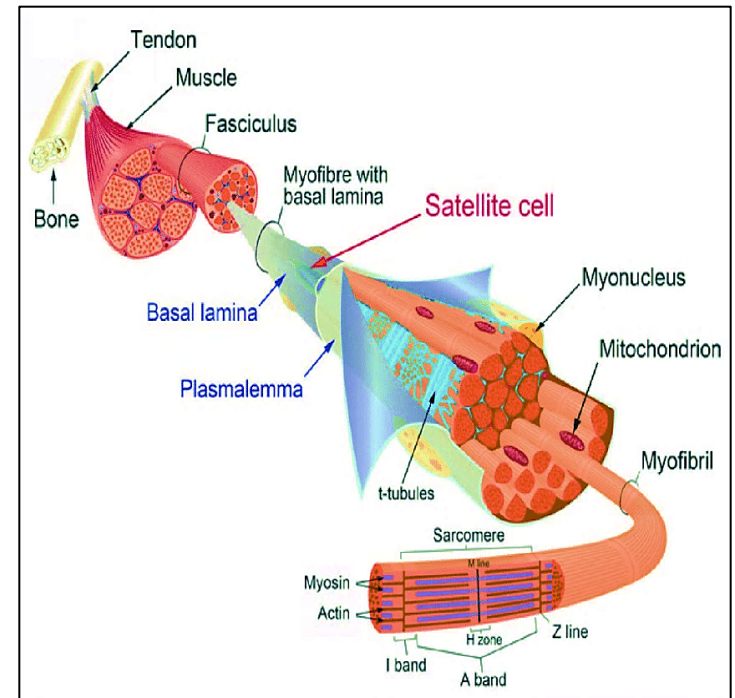

- ECM amount varies according to tissue type (**minimal** in **epithelium** and **plenty** in **connective tissue**)

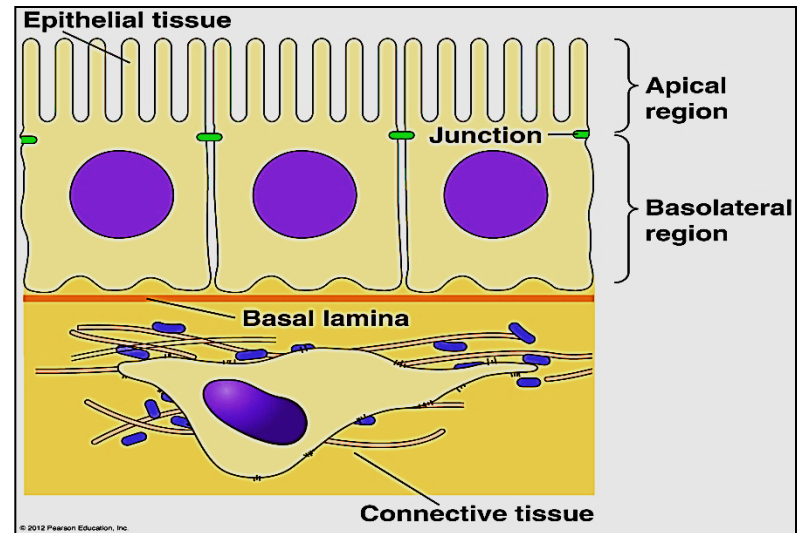

ECM consistency varies:

It may be **jelly like** e.g. connective tissue proper

It may be **rubbery** e.g. cartilage

It may be **hard** e.g. bone

It may be **fluid** e.g. blood

Functions:

1-Support of cells

2-Supply of nutrition and oxygen, communication

3-Removal of waste products

Organization of the human body

Human body is organized as follow:

1. Cells



2. Tissues



3. Organs



4. Systems

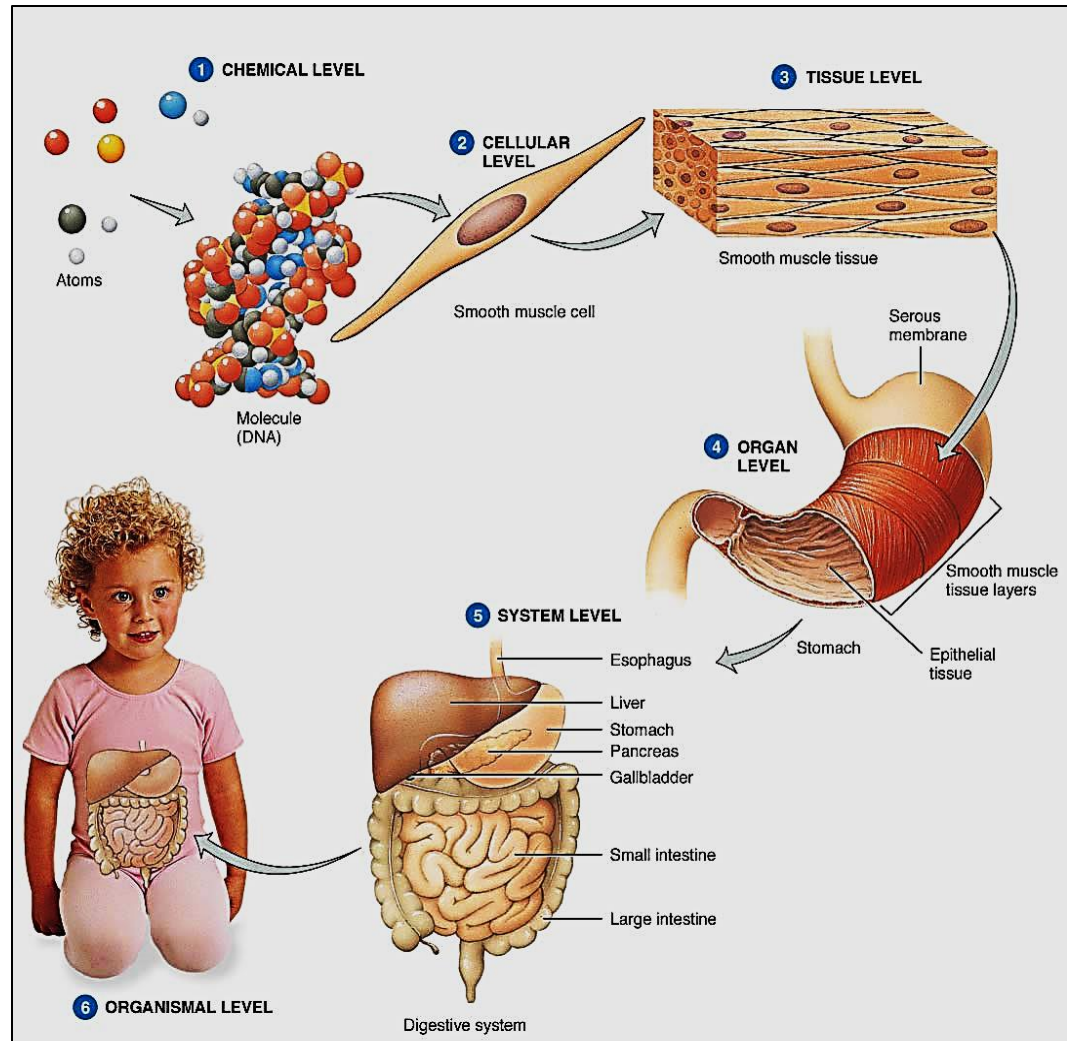

Tissues

- All organs of the body are composed of 4 basic tissues in various combinations.
- Each basic **tissue** is formed of special types of cells have the same general features and perform specific functions.

The four basic tissues are:

1. Epithelial tissue
2. Connective tissue
3. Muscular tissue
4. Nervous tissue

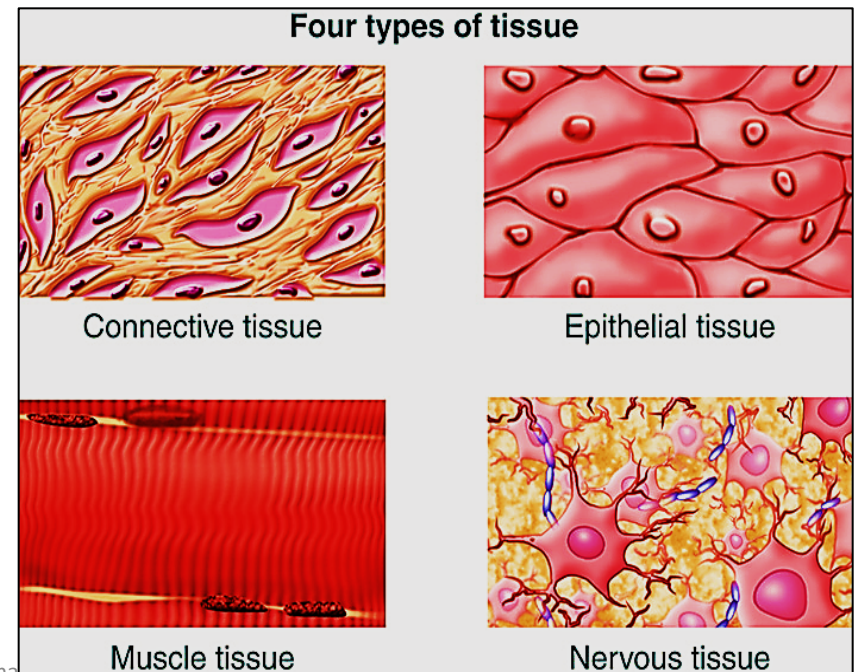

Organs

Each organ is formed of different kinds of tissues that perform together a special function.

Examples of organs :

The kidney

The liver

The lung

The stomach.....etc

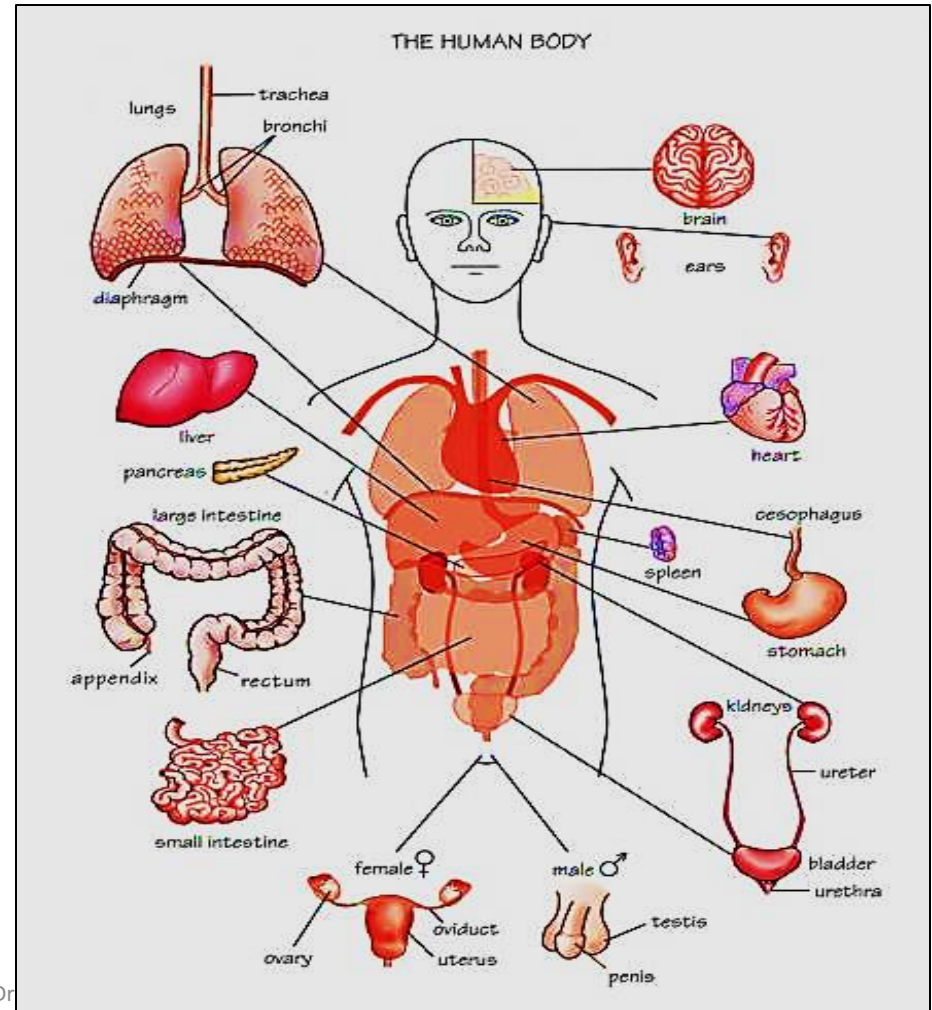

Systems

A system is an organization of different organs that together perform integrated complex functions of the body.

Examples of systems :

The urinary system

The digestive system

The respiratory system.....etc.

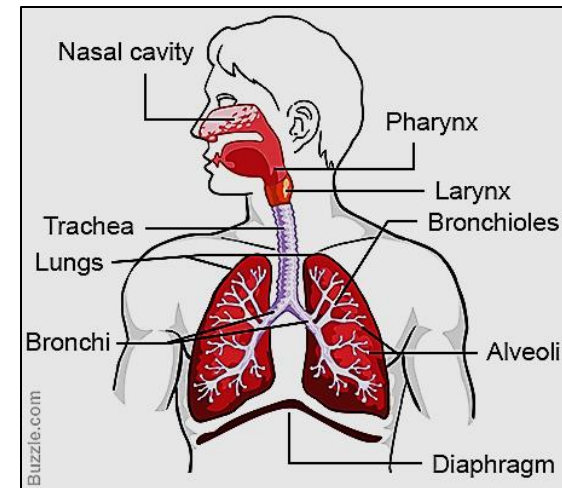
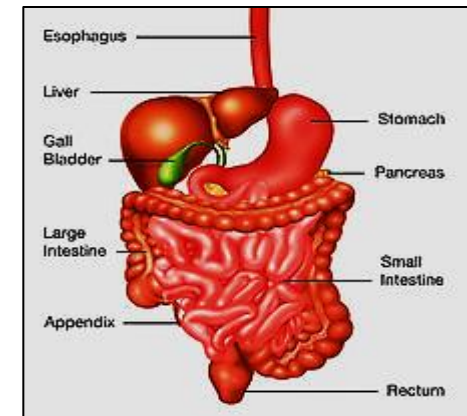
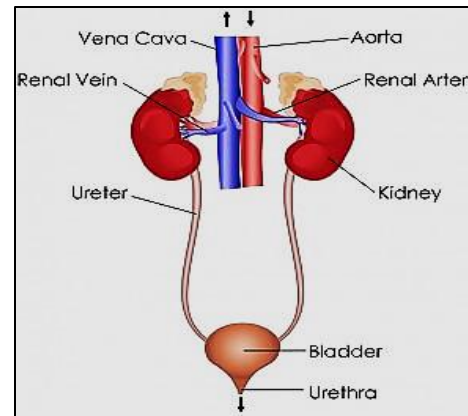

Microscopy

Is the standard optical instrument for generating magnified image & to examination of histological

Types:

1. Light microscope (LM)
2. Phase contrast microscope
3. Differential interference microscope
4. Fluorescence microscope
5. Confocal microscope
6. Electron microscope (Transmission and scanning)

1- Light microscopy (LM)

- The widely used microscope
- LM uses visible **light source + condenser lens** (to send light through the object).
- The **image** of this object is **magnified** by two **sets of lenses**:
 1. **Ocular lens** (10)
 2. **Objective lenses** (5 ,10 , 40)
- Total magnification power = 1×2
e.g. $10 \times 40 = 400X$ times

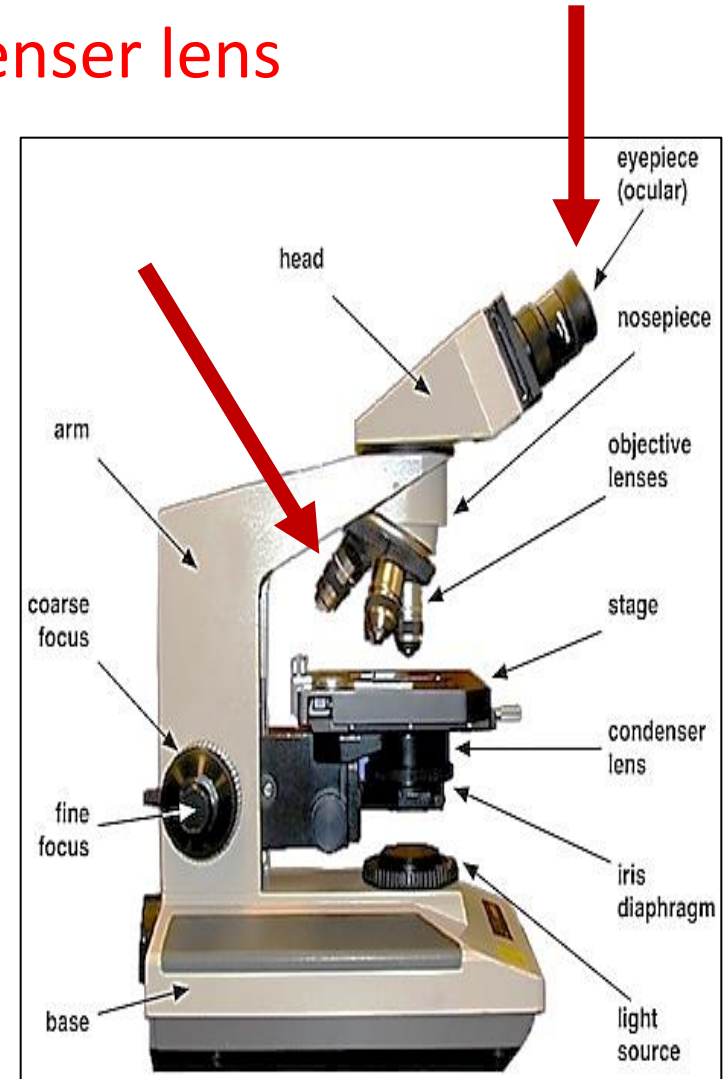

• The capacity of microscopes depends on:

1. **Magnification power**: the power to enlarge objects .

2. **The resolution power** : is the smallest distance between two particles that can still be seen by eye or camera as two separate entities & not as a single object (done by : lenses)

The magnification is of value only when accompanied by high resolution.

• The resolution power of:

1. Healthy naked eye = 0.2 millimeter

2. L M = 0.2 micrometer (um)

3. EM = 0.2 nanometer (nm)

Equivalent lengths:

1 millimeter (mm) = 1000 micrometer (micron)

1 micrometer (um)= 1000 nanometer

1 nanometer(nm)= 10 angstrom

Binocular light microscopy



2-Phase contrast microscope

- It depends on the idea that some lens systems can produce visible images from **transparent objects (unstained)**.
- The principal is that light changes speed when passes through cellular and extracellular structures & with different refractive indices.
- Objects appear lighter or darker to each others.
- It is useful in examining **living cells & tissue cultures e.g. blood cells and sperms**

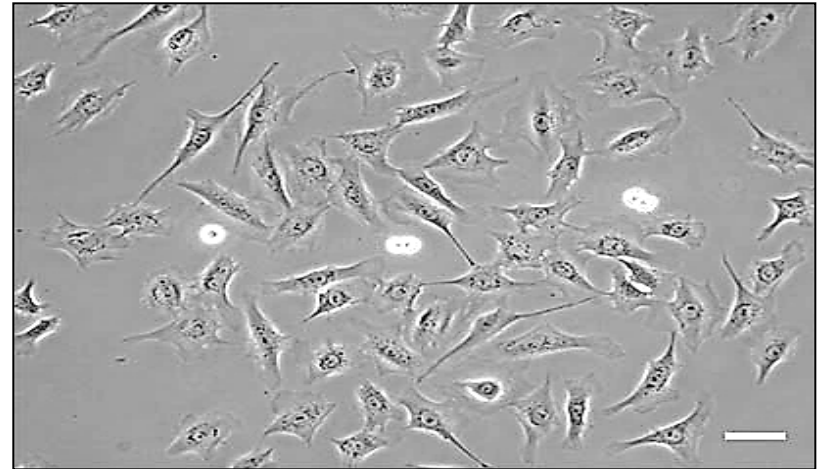

3- Differential interference contrast microscope

- The interference microscope (Nomarski microscopy) is a version of phase contrast microscope (used for transparent or unstained samples).
- The obtained image appears to have **three dimensional characters.**
- It utilizes **two separate beams of light.**

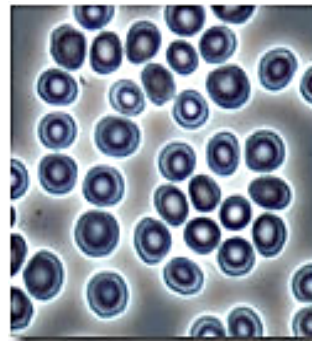

(a)



(c)



(e)

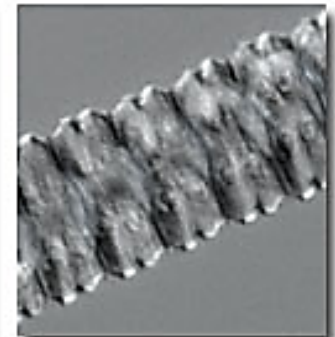
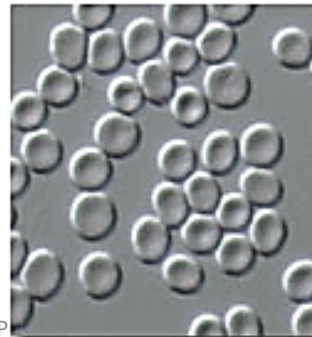

DIC microscopy

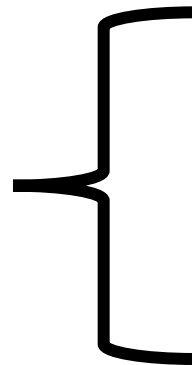

4- Fluorescence microscopy

- Certain substances absorb invisible ultraviolet light of short wavelength
- and emit (reflect) it as visible light of long wavelength and are known to exhibit **fluorescence** (physical property).
- This microscope is provided with **special lamp** that can **emit ultraviolet rays** which pass through the tissue.
- Fluorescent stains are used : Acridine orange, DAPI (immuno-histological techniques)
- It can be used to **visualize DNA, RNA, proteins and antigen antibody complex (antibodies labeled with fluorescence)**

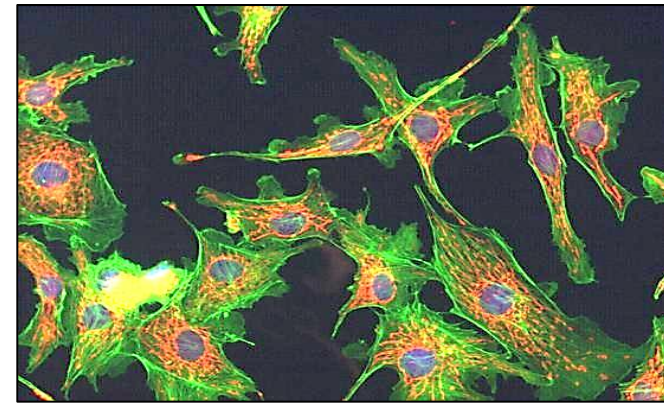

5- Confocal laser microscope (3D)

- * The illumination is provided by a **laser source**.
- The specimen should be labeled by fluorescent molecules
- Uses: increase optical resolution and contrast (better image)
- The **LASER** light passes **through a small hole (to avoid photo bleaching) to examine fine details**
- It is connected to a computer system to reconstruct full image of the specimen

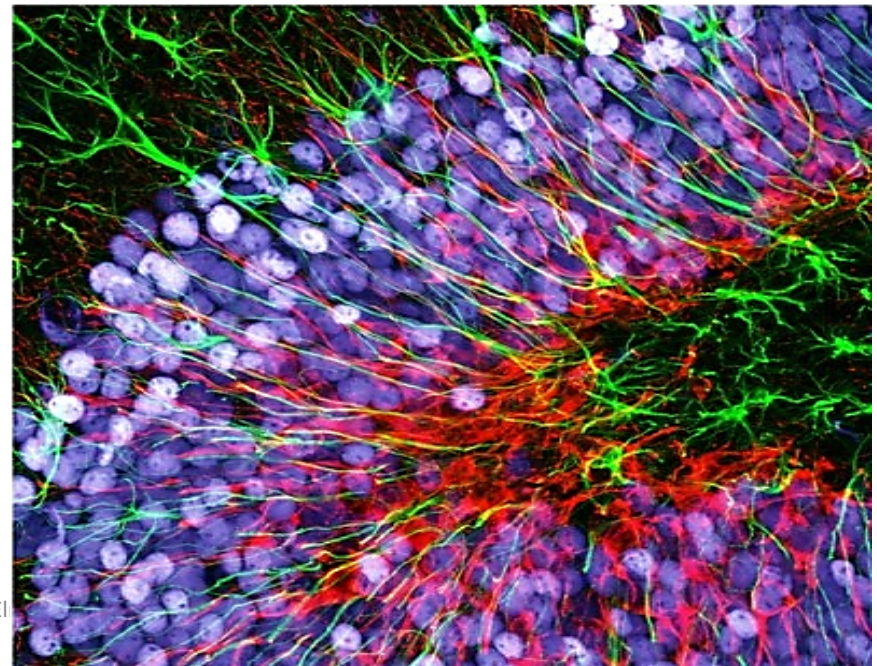

6- The Electron Microscope (EM)

- Technique is used to obtain high resolution images
- **Beam of electrons** is used as source of light
- The image is formed from the interaction of the electrons with the specimen as the beam travelling through it
- Beam passes through a vacuum tube
- The lenses are electromagnetic coils instead of glass lenses



- The lenses are electromagnetic coils instead of glass lenses

Electromagnetic lens

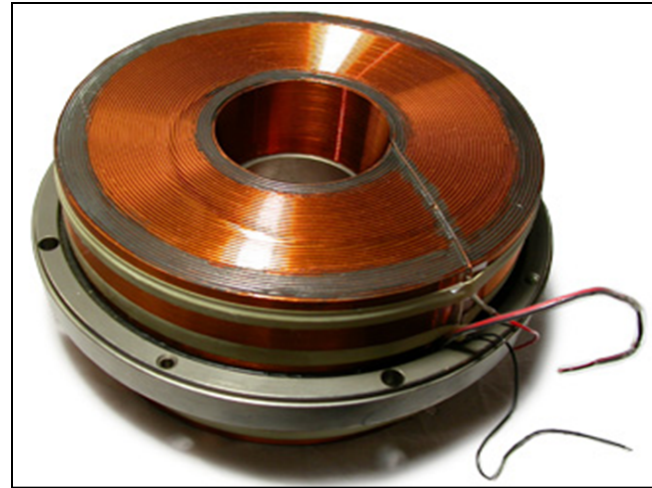

Illuminating system consists of:

Consists of: electron gun & condenser lens

- Condenser lens is capable of generating circular magnetic field that act to focus electrons on the specimen

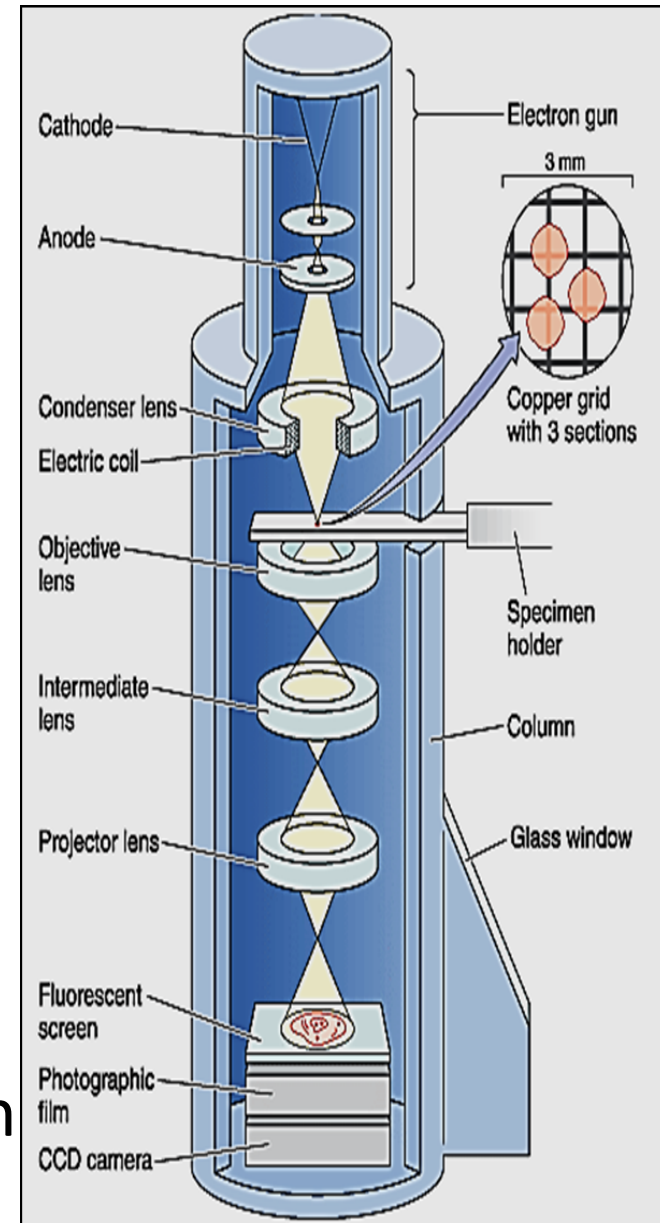

Imaging system consists of :

A- Another electromagnetic lenses (2-3)

B- Screen

- The objective lens is used to refocusing the electrons after they pass through the specimen & form image
- The projector lens is to enlarge the image of the object and projecting it into the fluorescent screen

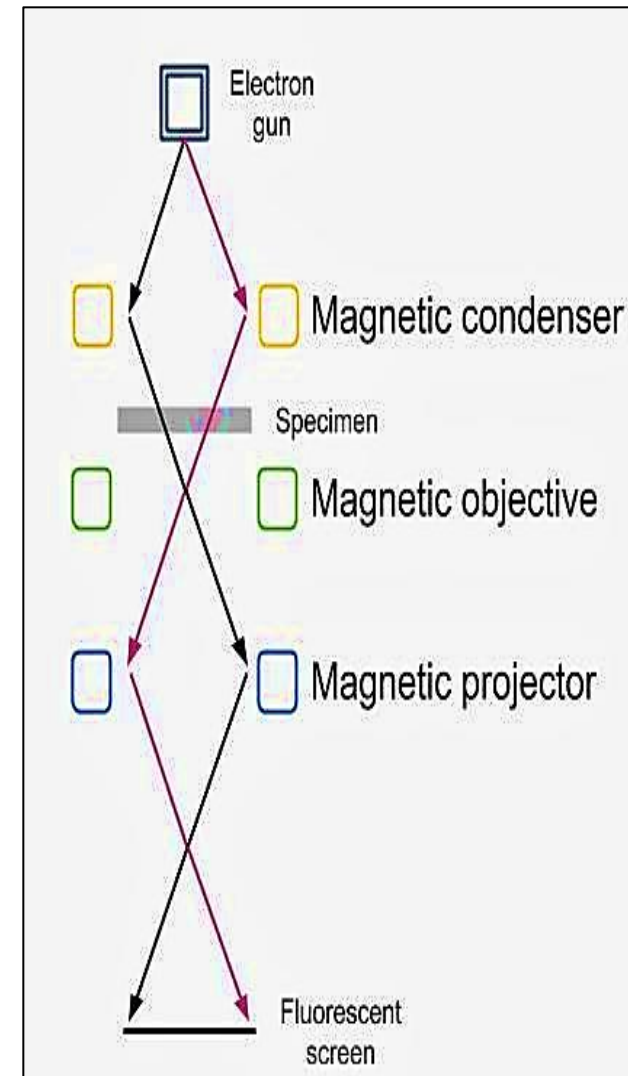

- The image appears on screen plate which glows when being hit by electrons

- Images can be detected as:
Light areas (**electron lucent**) &
dark areas (**electron dense**)
Corresponding to areas through
which electrons readily passed



The tissues and cells need special preparation & then cut into very thin sections

(**ultra thin sections** = 0.01 of the micron)

Then collected on a copper metal grid



Embedding in resin

Copper grid slides

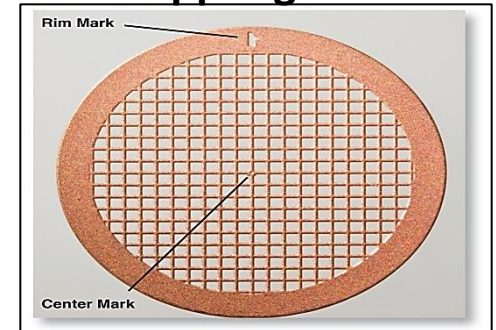

- During preparation sections are stained with salts of heavy metals like **lead nitrate** and **uranyl acetate** that precipitate in tissues.
- EM can magnify the image thousands of times (up to 200.000 times).
- The resolution power = 0.2 nanometer(nm)
- For permanent records, **photos are made**

Types of EM

• **Transmission EM (TEM)** : where electron beams pass through the specimen. It shows the details of internal structures of cells. **Resolution power: 0.2 nanometer**

TEM

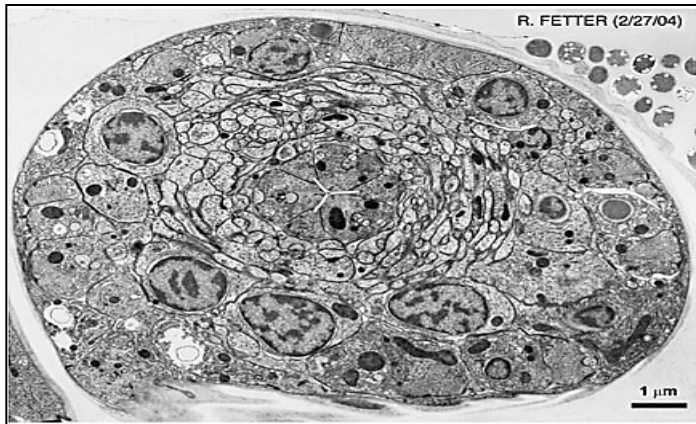

SEM

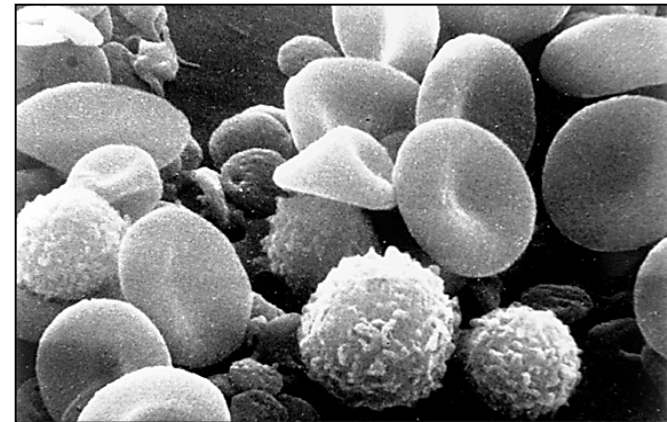

• **Scanning EM (SEM)** : a special type of EM where electron beams are reflected from the surface of coated specimen. This gives a three dimensional image of a specimen. **Resolution power: 10 nanometer**

LM & EM



LM

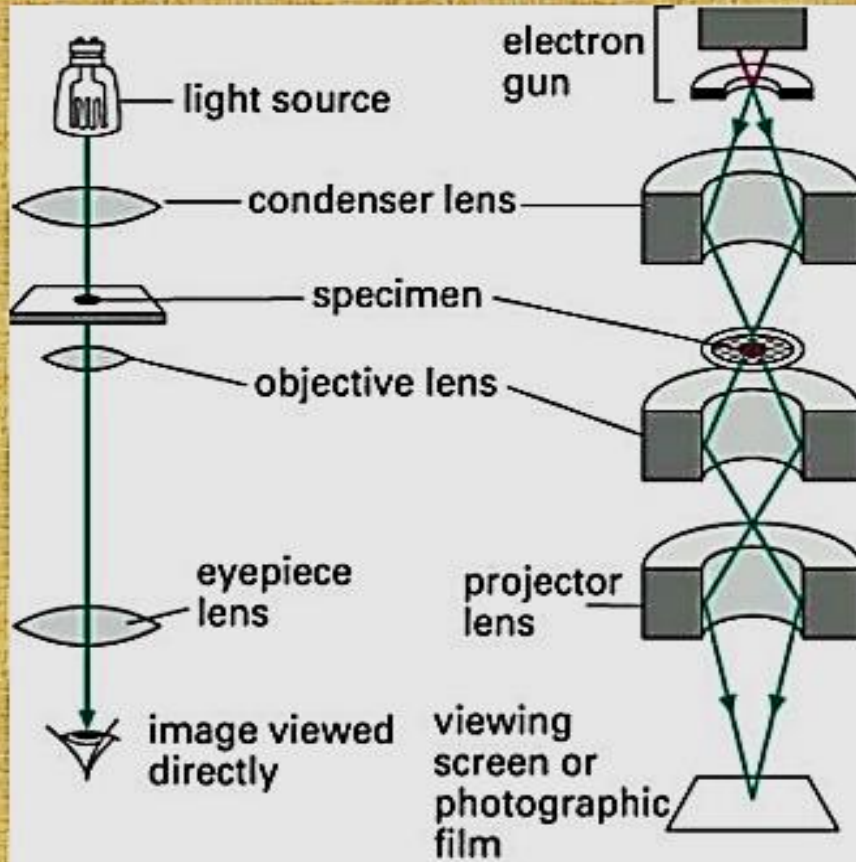

EM

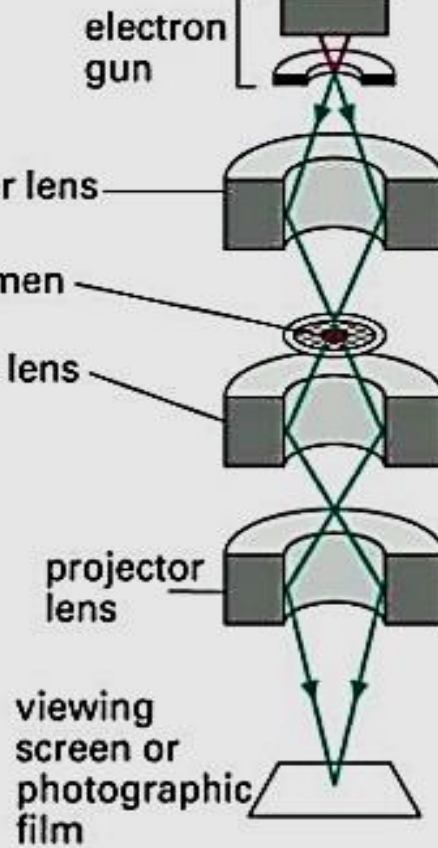

Thank you

